

BTE5000 / PTE5000 / PTU5000 Series

Precision differential pressure transmitters

FEATURES

- 25 mbar to 10 bar, 0.3 to 150 psi differential pressure
- 1...6 V or 4...20 mA output¹²
- Precision temperature compensated and calibrated
- Rugged aluminium housing
- Female 1/8" BSP and 1/8" NPT fittings

MEDIA COMPATIBILITY

Pressure inlet:
Non-corrosive, non-ionic media such as air, dry gases and the like

Housing:
Aluminium, protection class IP 67 (according to DIN EN 60529, NEMA 6)¹



SPECIFICATIONS^{10,11}

Maximum ratings

Supply voltage	12...32 V
Output current BTE(M)/PTE/PTU5...D1...	
Source	20 mA
Sink	10 mA
Output current BTE(M)/PTE/PTU5...D4...	30 mA
Temperature limits	
Storage	-40...85 °C
Operating	-25...85 °C
Compensated	0...70 °C
Proof pressure ²	
BTEM5x025... / PTx5000.3...	0.35 bar / 5 psi
BTEM5x070..., BTEM5x350... / PTx5001..., PTx5005...	1.4 bar / 20 psi
all others	2 x rated pressure
Pressure at any port ³	
BTEM5x025... / PTx5000.3...	3.5 bar / 50 psi
all others	12 bar / 175 psi

ELECTRICAL CONNECTION

1...6 V output version

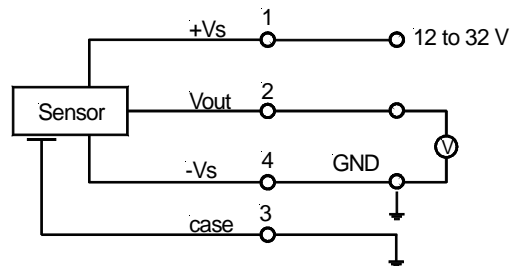

4...20 mA output version

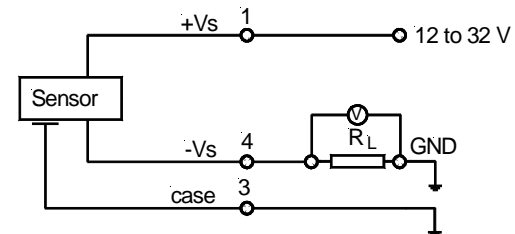

BTE5000 / PTE5000 / PTU5000 Series

Precision differential pressure transmitters

COMMON PERFORMANCE CHARACTERISTICS⁸

Characteristics		Min.	Typ.	Max.	Unit
Thermal effects (0 to 70°C) ⁶	Offset all ≤ 70 mbar / 1 psid devices all 350 mbar / 5 psid devices all others		±0.025 ±0.008 ±0.005 ±0.001	±0.125 ±0.040 ±0.025 ±0.045	%FSO/°C
	Span				
Non-linearity and hysteresis ⁴			±0.2	±1	%FSO
Long term stability ⁵			±0.2		
Output noise (0 ≤ f ≤ 1 kHz)			0.04		
Response time (10 to 90 %)			1		ms

INDIVIDUAL PERFORMANCE CHARACTERISTICS⁸

1...6 V output versions ($V_s = 15\text{ V}$, $t_{amb} = 25^\circ\text{C}$, $R_L > 100\text{ k}\Omega$, com. mode pressure = 0)

Characteristics		Min.	Typ.	Max.	Unit
Zero pressure offset	BTE(M)5P... / PTx5P...	3.4	3.5	3.6	V
	all others	0.9	1.0	1.1	
Full scale span ⁷	BTE(M)5P... / PTx5P...	2.4	2.5	2.6	
	all others	4.9	5.0	5.1	
Full scale output			6.0		
Power supply rejection	Offset		0.05		%FSO/V
	Span		0.03		
Output impedance				50	Ω
Power consumption			60		mW

4...20 mA output versions ($V_s = 15\text{ V}$, $t_{amb} = 25^\circ\text{C}$, $R_L = 100\text{ }\Omega$, com. mode pressure = 0)

Characteristics		Min.	Typ.	Max.	Unit
Zero pressure offset	BTE(M)5P... / PTx5P...	11.9	12.0	12.1	mA
	all others	3.9	4.0	4.1	
Full scale span ⁷	BTE(M)5P... / PTx5P...	7.9	8.0	8.1	
	all others	15.9	16.0	16.1	
Full scale output			20.0		
Power supply rejection	Offset		0.05		%FSO/V
	Span		0.03		
Output impedance				0.1	Ω
Power consumption ($I_L = 20\text{ mA}$)			260		mW

BTE5000 / PTE5000 / PTU5000 Series

Precision differential pressure transmitters

LOAD LIMITATION

4...20 mA output versions

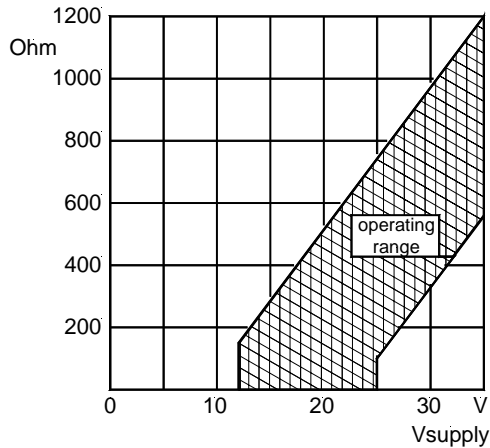

ELECTROMAGNETIC CAPABILITY⁹

	Test conditions	Criterion	Interference
Radiated, radio frequency electromagnetic field immunity (RFI)	EN61000-4-3: 10 V/m, 80 to 1000 MHz 80 % AMC (1 kHz)	A	<1 %FSO
Electrical fast transient / burst immunity (EFT)	EN61000-4-4: ±2 kV	B	<1 %FSO
Electrostatic discharge immunity test (ESD)	EN61000-4-2: ±4 kV, contact discharge ±8 kV, air discharge	B	<1 %FSO
Immunity to conducted disturbances induced by radio-frequency fields	EN61000-4-6: 0.15 to 80 MHz 10 V, 80 % AMC (1 kHz)	A	<1 %FSO

Specification notes:

1. IP 67 protection for BTE(M)5...A / PTx5...A is given with locked connector only.
2. Proof pressure is the maximum pressure which may be applied without causing damage to the sensing element.
3. This is the highest pressure which can be applied to any port at any time. At the same time the differential pressure between the ports H and L must not exceed the maximum proof pressure.
4. Non-linearity refers to the **Best Straight Line** fit measured for offset, full scale span and 1/2 full scale span.
5. Long term stability is the change in output after one year or 1 million pressure cycles.
6. Thermal effects tested and guaranteed from 0 - 70 °C relative to 25°. All specifications shown are relative to 25°C.
7. Full scale span is the algebraic difference between the positive full scale output and zero pressure offset.
8. Higher pressure applied to port H.
9. Test are in accordance with EN 61000-6-2.
10. CE-labelling is in accordance with 2004/108/EC.
11. The pressure transmitters must not be used as safety accessories according to article 1, 2.1.3 of the directive 97/23/EC.
12. 0...10 V square rooting output signal on special request.

BTE5000 / PTE5000 / PTU5000 Series

Precision differential pressure transmitters

OUTLINE DRAWING

Connector version

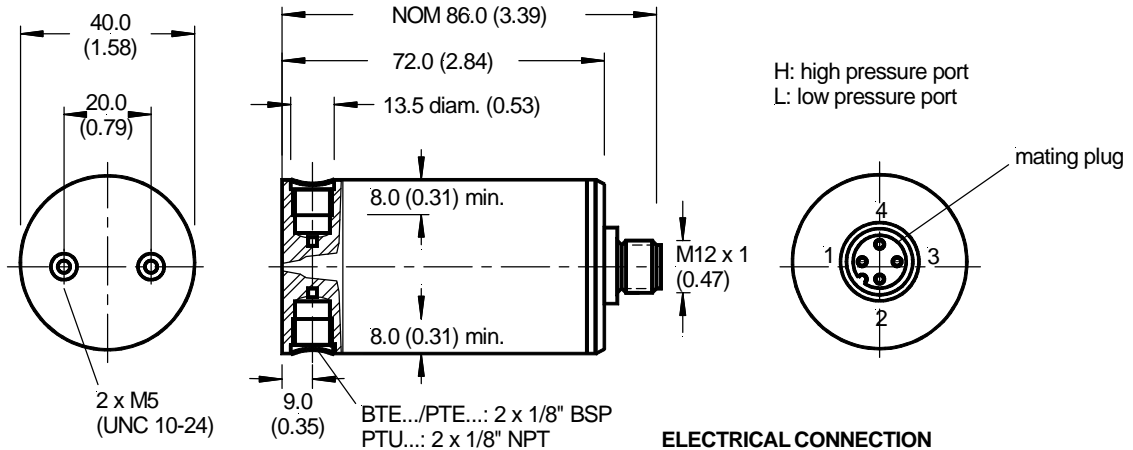

mass: typ. 170 g

ELECTRICAL CONNECTION

Pin	Connection	
	1 - 6 V output	4 - 20 mA output
1	+Vs	+Vs
2	Vout	NC
3	case	case
4	-Vs	-Vs

dimensions in mm (inches)

Cable version

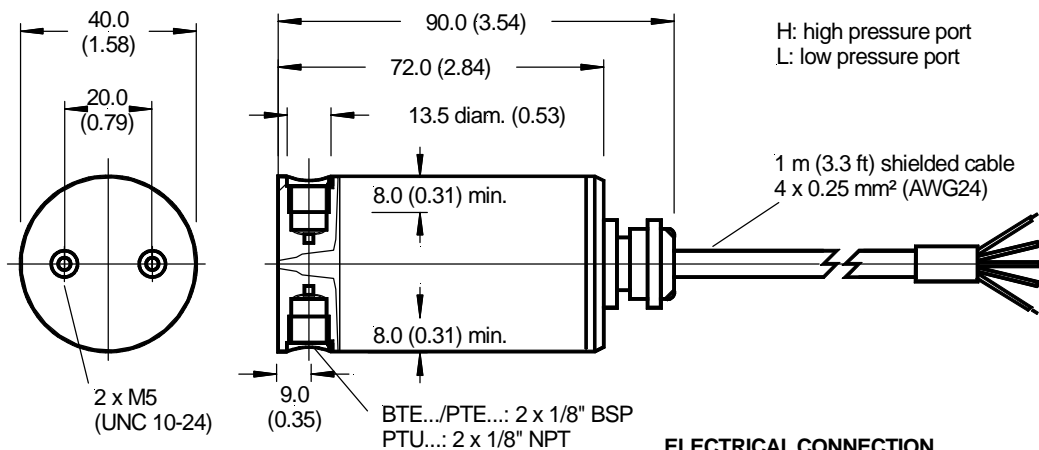

mass: typ. 220 g

ELECTRICAL CONNECTION

	Connection	
	1 - 6 V output	4 - 20 mA output
bare	case/shield	case/shield
brown	+Vs	+Vs
white	NC	NC
green	Vout	NC
yellow	-Vs	-Vs

dimensions in mm (inches)

BTE5000 / PTE5000 / PTU5000 Series

Precision differential pressure transmitters

RECOMMENDED CABLE/CONNECTOR ACCESSORY

for connector version

Order number **ZK000101**, other cable length on special request

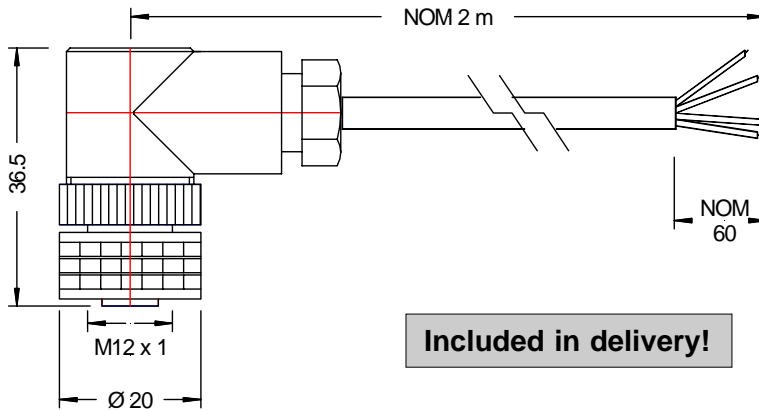

PIN CONNECTION

Pin	Flying lead end
1	brown
2	green
3	white + shield
4	yellow

ORDERING INFORMATION

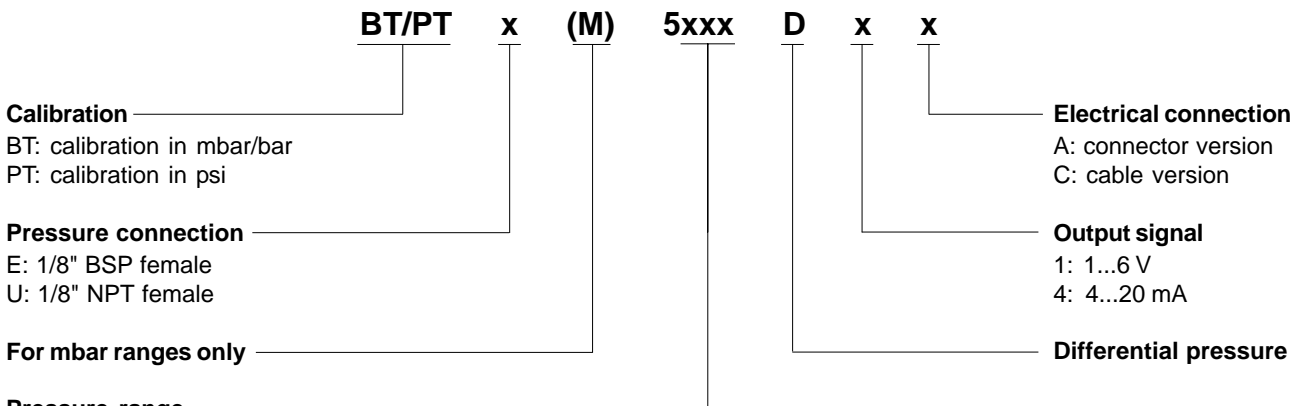

Pressure range

BTE5000 series

0025:	0...25 mbar
P025:	-25...+25 mbar
0070:	0...70 mbar
P070:	-70...+70 mbar
0350:	0...350 mbar
P350:	-350...+350 mbar
001:	0...1 bar
P01:	-1...+1 bar
002:	0...2 bar
005:	0...5 bar
010:	0...10 bar

PTE/PTU5000 series

000.3:	0...0.3 psi
001:	0...1 psi
P01:	-1...+1 psi
005:	0...5 psi
P05:	-5...+5 psi
015:	0...15 psi
P15:	-15...+15 psi
030:	0...30 psi
100:	0...100 psi
150:	0...150 psi

Other pressure ranges and options are widely available. Please contact First Sensor.

First Sensor reserves the right to make changes to any products herein. First Sensor does not assume any liability arising out of the application or use of any product or circuit described herein, neither does it convey any license under its patent rights nor the rights of others.