

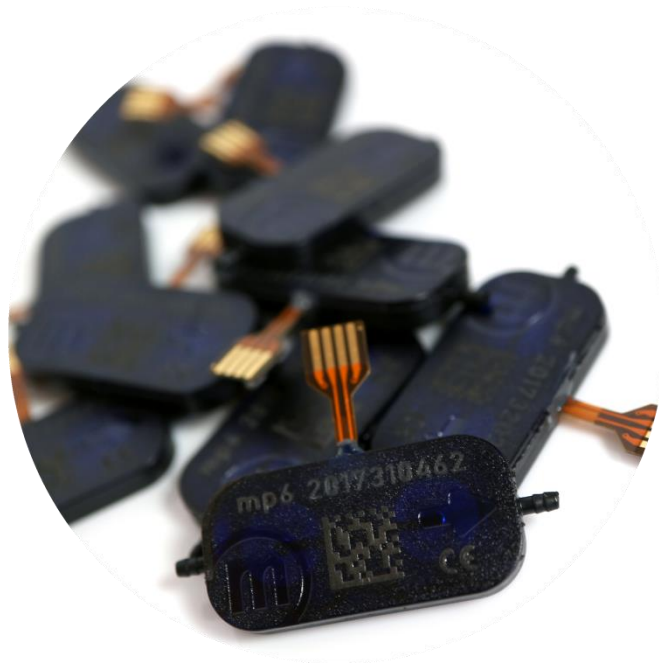

Operating Manual for Micropump mp6-series



Content

1	General.....	3
1.1	Declaration of conformity.....	3
1.2	Description of functions.....	3
2	Proper use.....	5
2.1	Intended purpose.....	5
2.2	Misuse.....	5
2.3	Staff selection and qualification.....	5
2.4	About this operating manual.....	5
3	Technical specifications.....	6
3.1	Technical specifications mp6 ¹	6
3.2	Technical specifications mp6-AIR ¹	7
3.3	Technical specifications mp6-AIR-HP ¹	8
3.4	Technical specifications mp6-pi ¹	9
3.5	Technical specifications mp6-pp ¹	10
3.6	Typical flow characteristics of Bartels Micropumps.....	11
3.7	Final inspection.....	12
4	Operating the micropump.....	13
4.1	Connecting the micropump.....	13
4.1.1	Connecting the mp6-series to the cable.....	14
4.2	Cleaning the system.....	16
4.3	Typical operation parameters.....	16
4.3.1	mp6.....	16
4.3.2	mp6-AIR.....	17
4.3.3	mp6-pp.....	17
4.4	Combination of micropumps.....	18



1 General

This operating manual contains all necessary instructions for the installation, commissioning, operation and maintenance of the mp6-series. The manual is intended to help you achieving optimal results in a short time and shall also assist avoiding possible sources of errors. The operating manual of the controllers and the accessories are available separately.

The products have been designed with state-of-the-art technology and in accordance with all relevant safety regulations. However, a risk of damage to the units, other property, the operator and/or other persons cannot be fully excluded.

Always ensure that specialized and trained personnel will comply with the following general instructions.

Therefore, please keep this manual and hand out copies as required.

Bartels Mikrotechnik GmbH rejects any responsibility for damages to persons or property resulting from non-compliance with the instructions in this manual. In this case all warranties shall be void.

1.1 Declaration of conformity

Bartels Mikrotechnik GmbH declares that the products are compliant to the RoHS directive 2011/65/EU. The controller comply with the requirements of EMV 2014/30/EU and CE markings have been affixed to the devices. Additionally, the controllers are also compliant to the EU Low Voltage Directive 2014/35/EU.

1.2 Description of functions

The micropumps have been developed for the transport of gases or liquids. The controllers have been developed for operating the micropumps. Bartels Mikrotechnik can assume no liability for damages resulting from the pump media. This applies especially for hazardous fluids.

The pumps must be operated with Bartels Mikrotechnik electronics. Bartels Mikrotechnik GmbH cannot guarantee the proper work of the units with customer specific electronics. If other controllers than the ones from Bartels Mikrotechnik are used, Bartels Mikrotechnik disclaims any warranty.

Moreover, please note that components of the controller and pump are operating with high-voltage.

Therefore, persons wearing pacemakers are recommended to avoid the operating system.

Bartels Mikrotechnik assumes no liability for abnormal handling, improper or negligent use of the micropump and the controller that is not conform to the specified purpose of the system. This applies



especially for micropump controllers, components and systems of other manufacturers, which have not been certified by Bartels Mikrotechnik.

We guarantee that the micropumps comply with the actual state of scientific and technical knowledge and due to this, the operational risks are limited to a minimum.

Do not open the housing of the micropump and the controllers. In those cases, Bartels Mikrotechnik cannot issue a guaranty anymore. Please keep this manual safe and give a copy to all users.



2 Proper use

2.1 Intended purpose

The micropump is intended for pumping liquids or gases with varying flow rates controlled by the electronics. The controllers are intended for operating the micropumps. Any other use of the micropump or controller unit is deemed improper.

Do not make any modifications or extensions to the pump or controller without the prior written consent of the manufacturer. Such modifications may impair the safety of the unit and are prohibited! Bartels Mikrotechnik GmbH rejects any responsibility for damage to the unit caused by unauthorized modifications to the pump and risk and liability are automatically transferred to the operator.

2.2 Misuse

The use of liquids, which may alone or in combination create explosive or otherwise health-endangering conditions (including vapors) is not permitted.

2.3 Staff selection and qualification

All work in connection with the installation, assembly, commissioning/decommissioning, disassembly, operation, servicing, cleaning and repairing of the pump and the controller must be carried out by qualified, suitably trained and instructed personnel. Work on electrical components and assemblies must be carried out by personnel with the necessary qualifications and skills.

2.4 About this operating manual

Warnings and important notes are clearly identified as such in the text. The relevant text sections feature a specific sign. However, this icon cannot replace the safety instructions. Therefore, carefully read all safety instructions in this manual. Warnings and important notes in this text are highlighted as shown below, according to the severity of the damage that might result from non-compliance.

 **DANGER**

DANGER INDICATES A HAZARD WITH A HIGH LEVEL OF RISK THAT, IF NOT AVOIDED, WILL RESULT IN DEATH OR SERIOUS INJURY.

3 Technical specifications

3.1 Technical specifications mp6¹

mp6	Order code: mp6
Pump type	piezoelectric diaphragm pump
Number of actuators	2
Dimensions without connectors	30 x 15 x 3.8 mm 1.1811 x 0.5906 x 0.1498 in.
Weight	2 g
Fluidic connectors	barbed tube clip, (outer diameter 1.9 mm, length 3.5 mm) ²
Electric connector	flex connector 1.25 mm pitch
Power consumption	~ 50 mW ⁴
Self-priming	yes ³
Pumping media	Liquids and mixtures
Operating temperature	0–70°C
Life time	5000 h ⁴
IP code	IP33 ⁵
Material in contact with media	polyphenylsulfone (PPSU) ⁶
Suitable evaluation controller	mp-x, mp6-EVA, mp6-OEM, mp6-QuadEVA, mp6-QuadOEM and mp6-QuadKEY
Typical values of flow and back pressure for selected media (values defined with mp-x: 100 Hz, 250 V, SRS):	
Liquids – water	
typ. volume flow	7 ml/min ^{4,7}
typ. back pressure	600 mbar ^{4,7}

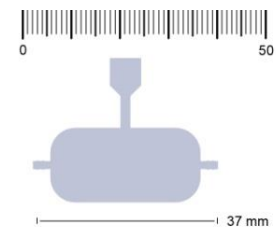

¹ Typical values. Values can vary under application conditions. Content is subject to changes without notice.

² Recommended tubing: Tygontubing 1.3 mm inner diameter.

³ Conditions: Suction pressure < 10 mbar, DI water, settings mp-x: 100 Hz, 250 V, SRS, the max. volume flow will be reached after a few minutes of operation time.

⁴ Conditions: DI water (25°C), room temperature 23°C, settings mp-x: 100 Hz, 250 V, SRS

⁵ Can be changed to IP44.

⁶ For media compatibility details please find more information in the corresponding data sheets.

⁷ Tolerances up to +20% and -15% are normal.

Please find more information concerning the controller and the equipment in the corresponding manuals.



3.2 Technical specifications mp6-AIR¹

mp6-AIR	Order code: mp6-AIR
Pump type	piezoelectric diaphragm pump
Number of actuators	2
Dimensions without connectors	30 x 15 x 3.8 mm 1.1811 x 0.5906 x 0.1498 in.
Weight	2 g
Fluidic connectors	barbed tube clip, (outer diameter 1.9 mm, length 3.5 mm) ²
Electric connector	flex connector 1.25 mm pitch
Power consumption	~ 150 mW ⁶
Self-priming	yes ³
Pumping media	gases
Operating temperature	0 – 70°C
Life time	5000 h ⁶
IP code	IP 33 ⁴
Material in contact with media	polyphenylene sulphone (PPSU) ⁵
Suitable evaluation controller	mp-x, mp6-EVA, mp6-OEM, mp6-QuadEVA, mp6-QuadOEM and mp6-QuadKEY
Typical values of flow and back pressure for selected media (values defined with mp-x: 300 Hz, 250 V, SRS):	
Gases	
typ. volume flow	20 ml/min (300 Hz) ⁶
typ. back pressure	100 mbar (300 Hz) ⁶

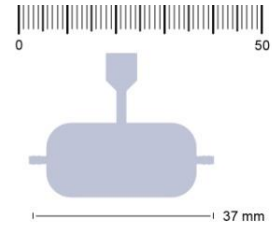

¹ Typical values. Values can vary under application conditions. Content is subject to changes without notice.

² Recommended tubing: Tygontubing 1.3 mm inner diameter.

³ Conditions: Gases, room temperature 23°C, settings mp-x: 300 Hz, 250 V, SRS, the max. volume flow will be reached after a few minutes of operation time.

⁴ Can be changed to IP44.

⁵ For media compatibility details please find more information in the corresponding data sheets.

⁶ Conditions: Gases, room temperature 23°C, mp-x: 300 Hz, 250 V, SRS

The mp6-AIR is a regular mp6 that was specifically measured for gas flow.

Please find more information concerning the controller and the equipment in the corresponding manuals.



3.3 Technical specifications mp6-AIR-HP¹

mp6-AIR-HP	Order code: mp6-AIR-HP
Pump type	piezoelectric diaphragm pump
Number of actuators	2
Dimensions without connectors	30 x 15 x 3.8 mm 1.1811 x 0.5906 x 0.1498 in.
Weight	2 g
Fluidic connectors	barbed tube clip, (outer diameter 1.9 mm, length 3.5 mm) ²
Electric connector	flex connector 1.25 mm pitch
Power consumption	~ 150 mW ⁶
Self-priming	yes ³
Pumping media	gases
Operating temperature	0 – 70°C
Life time	5000 h ⁶
IP code	IP 33 ⁴
Material in contact with media	polyphenylene sulphone (PPSU) ⁵
Suitable evaluation controller	mp-x, mp6-EVA, mp6-OEM, mp6-QuadEVA, mp6-QuadOEM and mp6-QuadKEY
Typical values of flow and back pressure for selected media (values defined with mp-x: 300 Hz, 250 V, SRS):	
Gases	
typ. volume flow	20 ml/min (300 Hz) ⁶
typ. back pressure	150 mbar (300 Hz) ⁶

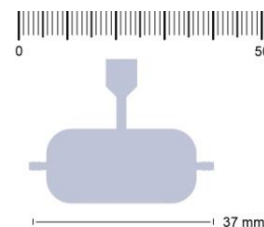

¹ Typical values. Values can vary under application conditions. Content is subject to changes without notice.

² Recommended tubing: Tygontubing 1.3 mm inner diameter.

³ Conditions: Gases, room temperature 23°C, settings mp-x: 300 Hz, 250 V, SRS, the max. volume flow will be reached after a few minutes of operation time.

⁴ Can be changed to IP44.

⁵ For media compatibility details please find more information in the corresponding data sheets.

⁶ Conditions: Gases, room temperature 23°C, mp-x: 300 Hz, 250 V, SRS

The mp6-AIR-HP is a regular mp6 that was specifically measured for gas flow.

Please find more information concerning the controller and the equipment in the corresponding manuals.



3.4 Technical specifications mp6-pi¹

mp6-pi	Order code: mp6-pi
Pump type	piezoelectric diaphragm pump
Number of actuators	2
Dimensions without connectors	30 x 15 x 3.8 mm 1.1811 x 0.5906 x 0.1498 in.
Weight	2 g
Fluidic connectors	barbed tube clip, (outer diameter 1.9 mm, length 3.5 mm) ²
Electric connector	flex connector 1.25 mm pitch
Power consumption	~ 50 mW ⁴
Self-priming	yes ³
Pumping media	Liquids and mixtures
Operating temperature	0–70°C
Life time	5000h ⁴
IP code	IP33 ⁵
Material in contact with media	Polyimid foil (PI), polyphenylsulfone (PPSU) ⁷
Suitable evaluation controller	mp-x, mp6-EVA, mp6-OEM, mp6-QuadEVA, mp6-QuadOEM and mp6-QuadKEY
Typical values of flow and back pressure for selected media (values defined with mp-x: 100 Hz, 250 V, SRS):	
Liquids – water	
typ. volume flow	7 ml/min ^{4, 8}
typ. back pressure	600 mbar ^{4, 8}

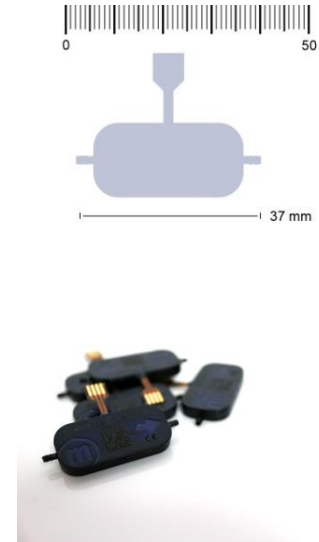

¹ Typical values. Values can vary under application conditions. Content is subject to changes without notice.

² Recommended tubing: Tygon tubing 1.3 mm inner diameter.

³ Conditions: Suction pressure < 10 mbar, DI water, settings mp-x: 100 Hz, 250 V, SRS, the max. volume flow will be reached after a few minutes of operation time.

⁴ Conditions: DI water (25°C), room temperature 23°C, settings mp-x: 100 Hz, 250 V, SRS

⁵ Can be changed to IP44.

⁷ For media compatibility details please find more information in the corresponding data sheets.

⁸ Tolerances up to +/- 15 % are normal.

Please find more information concerning the controller and the equipment in the corresponding manuals.



3.5 Technical specifications mp6-pp¹

mp6-pp	Order code: mp6-pp
Pump type	piezoelectric diaphragm pump
Number of actuators	2
Dimensions without connectors	30 x 15 x 3.8 mm 1.1811 x 0.5906 x 0.1498 in.
Weight	2 g
Fluidic connectors	barbed tube clip, (outer diameter MIN 1.77 mm - MAX 1.85 mm, length 3.5 mm) ²
Electric connector	flex connector 1.25 mm pitch
Power consumption	~ 50 mW ⁵
Self-priming	yes ³
Pumping media	liquids, gases and mixtures
Operating temperature	0 – 70°C
Life time	5000 h ⁵
IP code	IP 33 ⁴
Material in contact with media	polypropylene (PP) ⁶
Suitable evaluation controller	mp-x, mp6-EVA, mp6-OEM, mp6-QuadEVA, mp6-QuadOEM and mp6-QuadKEY
Typical values of flow and back pressure for selected media (values defined with mp-x: 100 Hz, 250 V, SRS):	
Liquids – water	
typ. volume flow	5 ml/min ^{5,7}
typ. back pressure	650 mbar ^{5,7}

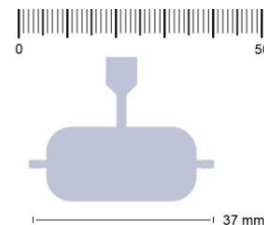

¹ Typical values. Values can vary under application conditions. Content is subject to changes without notice.

² Recommended tubing: 1.02 mm inner diameter. MIN & MAX values due to injection molding shrink.

³ Conditions: Suction pressure < 10 mbar, DI water, settings mp-x: 100 Hz, 250 V, SRS, the max. volume flow will be reached after a few minutes of operation time.

⁴ Can be changed to IP44.

⁵ Conditions: DI water (25°C), room temperature 23°C, settings mp-x: 100 Hz, 250 V, SRS

⁶ For media compatibility details please find more information in the corresponding data sheets.

⁷ Tolerances up to +/- 15% are normal.

Please find more information concerning the controller and the equipment in the corresponding manuals.



3.6 Typical flow characteristics of Bartels Micropumps

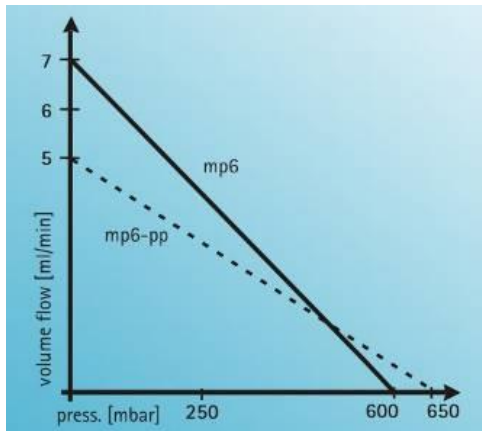

The flow rate of the pumps shows a linear dependency on the back pressure.

At 0 mbar back pressure the maximum pump rate can be achieved and at the maximum back pressure the flow rate is decreased to 0 ml/min.

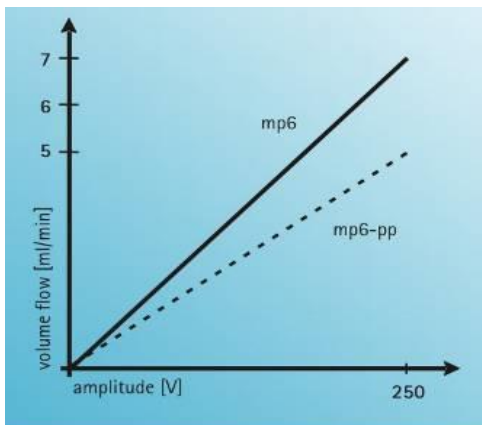

The amplitude defines the stroke of the actuator and therefore the displacement of the pumping media per pump cycles.

Increase in amplitude linearly increases the flow rate to the maximum.

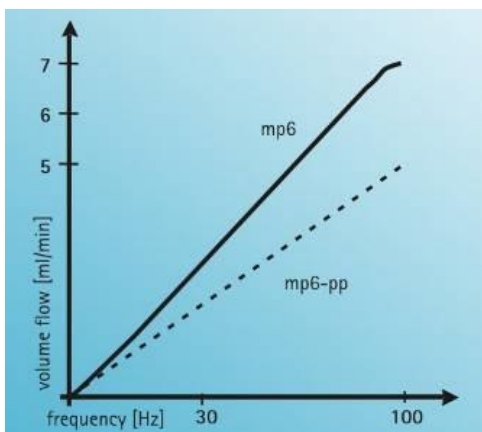

The frequency determines the number of pump strokes over time. Volume flow increases linear with frequency for a certain frequency range.

The diagram presents the maximum of volume flow at the micropumps resonant frequency.

At frequencies above the resonant point the flow rate decreases again.



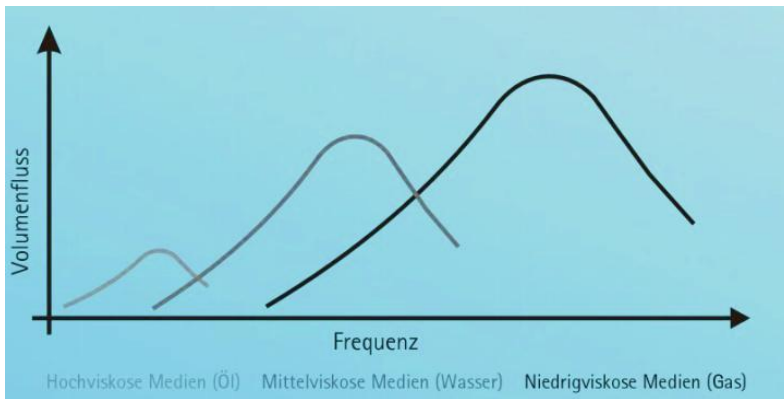

The resonance frequency and the maximum flow rate strongly depend on the viscosity of the media. The lower the viscosity, the higher the maximum flow rate and the resonance frequency.

3.7 Final inspection

After production, the micropumps have to pass a final inspection. They are tested concerning the maximum flow and back pressure.

Measurement conditions:

Pumping media: distilled water

Temperature: room temperature 23°C

Controller: extended box mp-x

Electrical Input: amplitude of 250 Vpp and SRS-Signal with 100 Hz (for liquids) and 300 Hz (for gases)

Measurements with sensors:	
volume flow	range: 0 - 10 ml/min accuracy: +/- 1% FS (=0.1 ml/min)
pressure	range: 0 - 1 bar accuracy: +/- 0.35% (= 3.5 mbar)

Other application specific outgoing inspections can be offered for all pumps upon customer demand.

In order to guarantee proper function of the delivered goods and exclude transportation damages please check the incoming devices according to specifications after receipt.

Based on these results a replacement can be carried out within 14 days after delivery free of costs.



4 Operating the micropump

In this chapter, operation of the micropump during the evaluation is described. This chapter provides information on the proper connection of the pump with tubing and electrical cables and typical driving parameters to start the evaluation.

4.1 Connecting the micropump

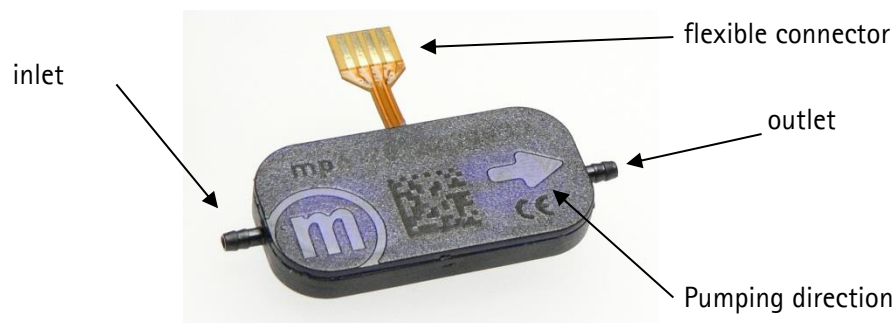

Please connect suitable tubes to the inlet and outlet. The tubing should have an inner diameter of ~ 1.3 mm for the mp6, mp6-AIR, mp6-AIR-HP and mp6-pi and ~ 1.2 mm for the mp6-pp. The micropump has to be connected to a suitable controller as described in the next sections.

Tygon; ID = 1.30 mm; OD = 3 mm

Tygon; ID = 1.02 mm; OD = 2.72 mm

The electrical connection of the micropumps flexible connector is described in the corresponding chapter. The flexible connector will be attached to the desired controller.

On both type pumps, traces of surface corrosion may appear on the electrical connector. This corrosion only causes a visual influence, negative effects on the pump performance could not be detected based on performance tests carried out by Bartels Mikrotechnik. Because of the mechanical fixation inside the electrical connector and due to the use of elevated driving voltages it is ensured that the pump performance is not affected by the surface corrosion. In a long term, we will work on improving the production process. Until then, referring to the unrestricted pump performance we ask our customers to excuse visible defects on the electrical connector.

In general, the micropump can be driven with positive alternating voltages with maximum amplitude of 250 V at a frequency between 0 and 300 Hz. A rectangular signal results in best fluidic performance

while a sine wave minimizes the audible noise. The actuators must be driven with a 180° phase shift in the signal.

If a pump will be damaged while using a customer's controller, we do not provide any warranty. We recommend using our dedicated controllers.

 **DANGER**
THE MP6-SERIES MICROPUMPS ARE OPERATED AT HIGH VOLTAGES. BEFORE OPERATION, MAKE SURE THAT ALL SPECIFIC REGULATIONS FOR ELECTRICAL SAFETY ARE FULLILLED.

4.1.1 Connecting the mp6-series to the cable

The pumps can be connected via a FCC connector. The layout of the connector and pin assignment of the pumps is as shown below. Each piezo (P1 / P2) has a single lead for the negative (-P1/-P2) and the positive (+P1/+P2) supply voltage.

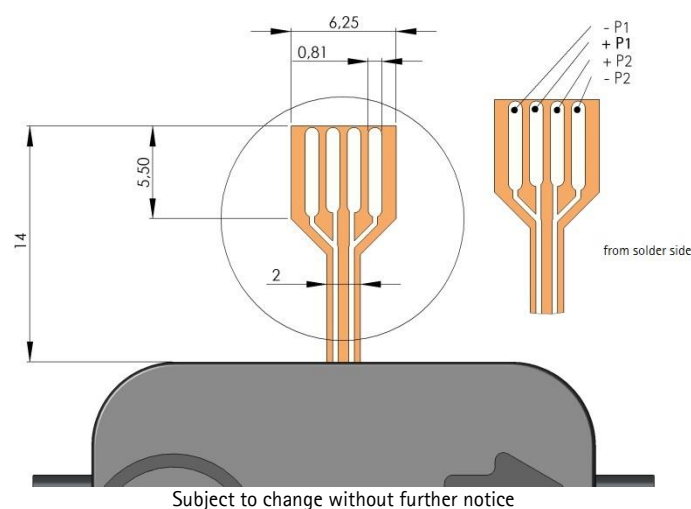

The recommended connector is a 4-pin 1.25 mm pitch FCC connector manufactured by Molex. The straight version part number 39 53 2045. An alternative is the angulated version with the part number 39 53 2044.

The connector is available in different versions to fit various applications. Reference drawings and further specifications are available under www.molex.com.

The recommended maximum wire length between controller and the pump is 1 m. The customer has to assure that the assembly of pump, controller and electrical connection complies with the EMC regulations and electrical safety in the specific field of application.

To connect the pumps and Molex, refer to following three figures. Orientate both components as indicated on the first picture, the pumps facing downwards with its serial number marking (!) and the Molex connector with the four small openings visible from above. Then insert the mp6/mp6-pp flex into the Molex connector (Step1). Close the Molex connector to complete the interconnection between both components (Step 2).

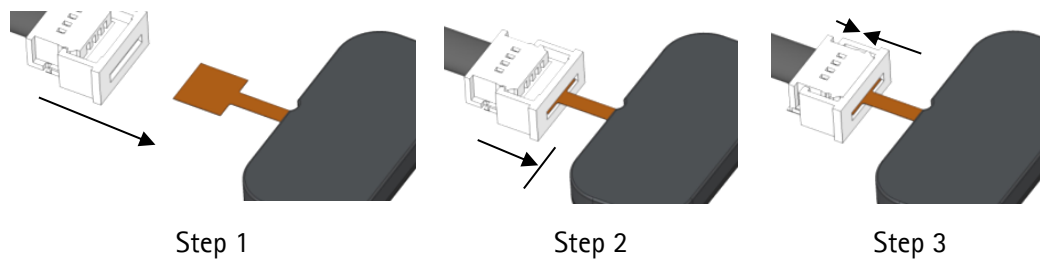

If the pump should be removed again, the Molex connector needs to be opened before removal!

In order to prevent damage to the flexible cable, the following points should be considered for the final pump assembly:

- the flexible connector must not be bent around sharp edges or kinked
- the flexible connector must not be bend on top or bottom of the pump
- the Molex connector is not water tight, additional sealing with e.g. silicone will be necessary
- fixation of the Molex connector in the final assembly is recommended

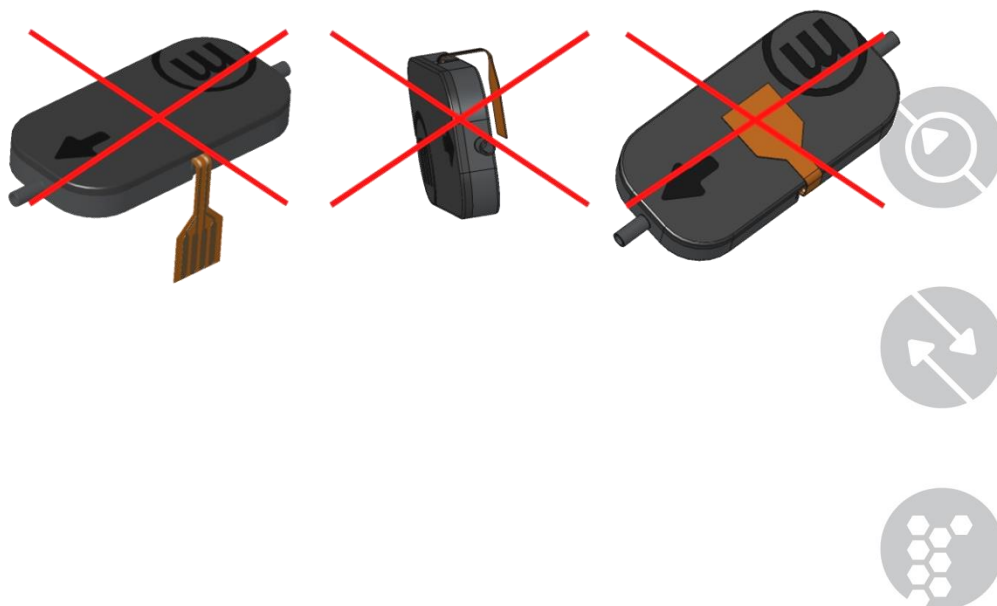

4.2 Cleaning the system

The pump can be washed with water, alcohol (isopropanol) or if necessary with weak acid by pumping or by flushing with the help of a syringe. **Flushing is only possible in pump direction!**

4.3 Typical operation parameters

4.3.1 mp6

The following applies to the media water. If gases are pumped, please refer to the chapter 4.3.2. Note that the regular mp6 can pump gases too, but is not specifically measured for it.

To achieve individual flow rates and optimal flow conditions, the driving parameters need to be tested, optimized and confirmed by testing under full application conditions. As an example, typical driving parameters are listed below to give a general orientation for testing. **The parameters have been obtained using the mp-x controller with the SRS signal preset.** Please refer to the corresponding manual for operation of the mp-x controller.

target volume flow	amplitude	frequency
7 ml/min	250 V	100-110 Hz
6 ml/min	250 V	80-90 Hz
5 ml/min	250 V	55-65 Hz
4 ml/min	250 V	40-50 Hz
3 ml/min	250 V	30-35 Hz
2 ml/min	220-240 V	20 Hz
1 ml/min	125-135 V	20 Hz
0,5 ml/min	90-100 V	15 Hz
0,25 ml/min	85-95 V	8 Hz
0,1 ml/min	80-90 V	3 Hz

As a general guideline, the amplitude should be kept as high as possible while varying the frequency. The flow curves present typical flow data, results may differ under varying operation conditions.

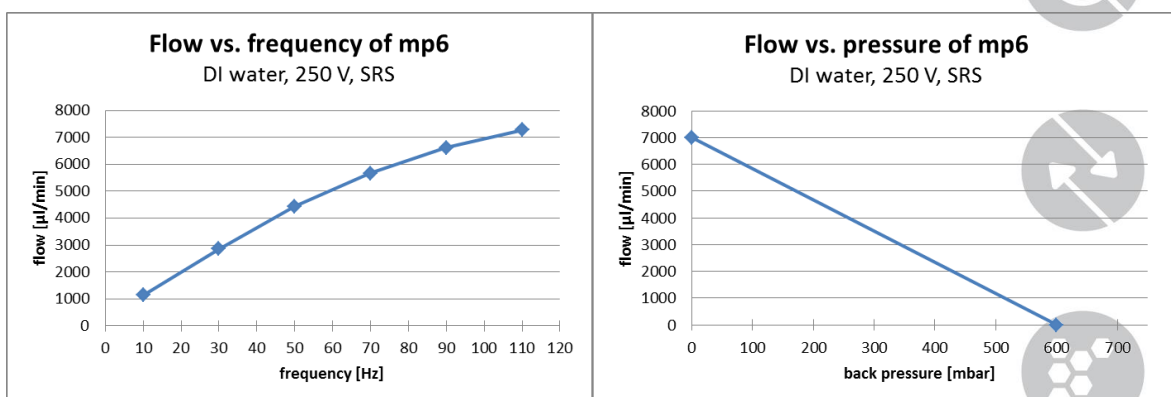

4.3.2 mp6-AIR

Driving the micropump with the controller mp-x at 300 Hz with 250 V, flow rates of typ. min. 20 ml/min and backpressures of typ. min. 100 mbar can be achieved.

In general, for driving the pump with air the following points should be taken into account:

- Higher frequencies should be used (compared to pumping water).
- Large amplitudes respectively driving voltages should be used.

With low frequencies and amplitudes, the volume flow and pressure generation is rather weak due to the passive character of the valves inside the micropump. These valves are more effective with fast and high pressure changes induced by the actuator.

If the desired flow rates should be small, the application of a restrictor is recommended. Please contact us about the right choice of the restrictor!

Please note the different frequency ranges of the control units.

To minimize audible noise, using the sine signal is recommended.

The signal has influence on volume flow and back pressure, thereby applies rectangular > SRS > sine.

4.3.3 mp6-pp

Again the following applies to the media water. Note that the mp6-pp can pump gases too, but is not specifically measured for it.

To achieve individual flow rates and optimal flow conditions, the driving parameters need to be tested, optimized and confirmed by testing under full application conditions. As an example, typical driving parameters are listed below to give a general orientation for testing. **The parameters have been obtained using the mp-x controller with the SRS signal preset.** Please refer to the corresponding manual for operation of the mp-x controller.

target volume flow	amplitude	frequency
6 ml/min	250 V	120-130 Hz
5 ml/min	250 V	90-100 Hz
4 ml/min	250 V	60-80 Hz
3 ml/min	250 V	40-50 Hz
2 ml/min	250 V	30 Hz
1 ml/min	180-190 V	20 Hz
0,5 ml/min	130-140 V	15 Hz
0,25 ml/min	120-130 V	8 Hz
0,1 ml/min	95-105 V	4 Hz

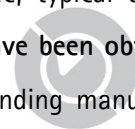

As a general guideline, the amplitude should be kept as high as possible while varying the frequency. The flow curves present typical flow data, results may differ under varying operation conditions.

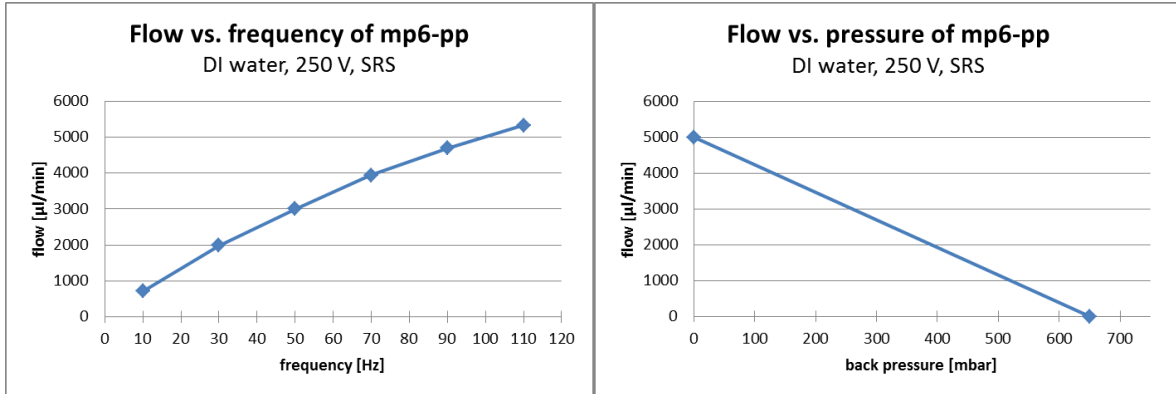

4.4 Combination of micropumps

The micropumps can be combined to achieve higher flow rates or pressure than the single unit can generate.

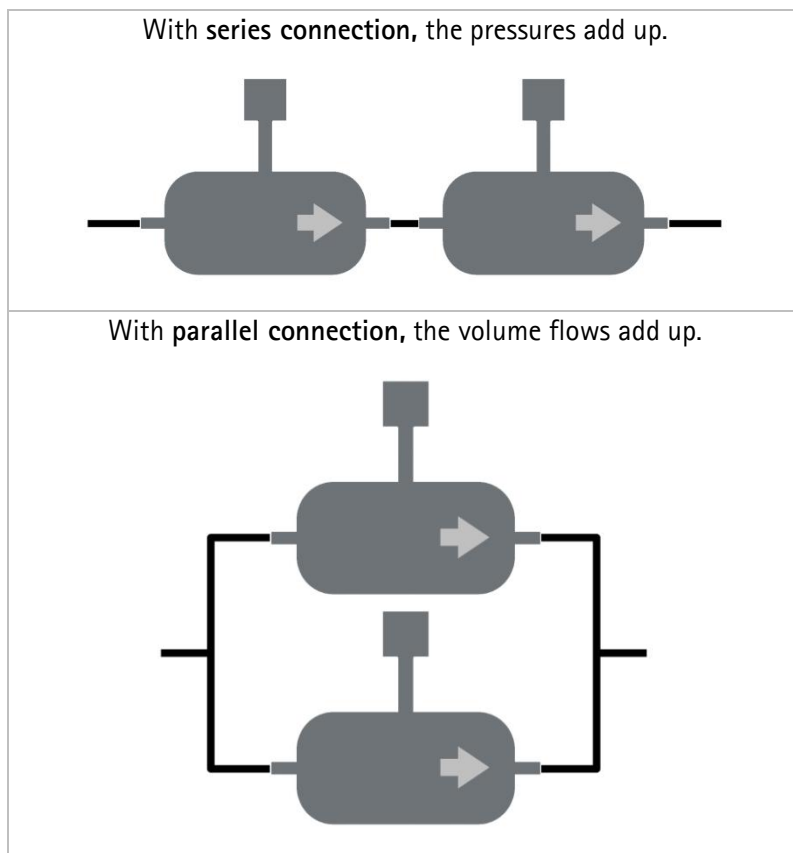

Bartels ikrotechnik

Bartels Mikrotechnik GmbH
Konrad-Adenauer-Allee 11
44263 Dortmund Germany

www.bartels-mikrotechnik.de
info@bartels-mikrotechnik.de

For tutorials and further information

Visit our BLOG:

<http://blog.bartels-mikrotechnik.de>

Or our YouTube channel:

<https://www.youtube.com/user/BartelsMikrotechnik>

You can also find us here:

Facebook

Twitter

Xing

Instagram

LinkedIn

Tel: +49-231-47730-500

Fax: +49-231-47730-501

