

LTC Series

Up to 1.7 LPM Free Flow



Markets

- Clinical Diagnostics
- Analytical Chemistry
- Printing

Applications

- Clinical Chemistry
- Wash and Waste Circuits
- Urinalysis
- Liquid Chromatography
- Large Format Printers
- Photo Processing Printers

Miniature Diaphragm Pumps (liquid)

LTC Miniature Diaphragm Pumps are offered in both brush and brushless DC motor drives that can be configured for your specific performance requirements and handle a wide range of liquid media over a wide range of pressures. LTC's patented Fluid-Blok™ Advanced Sealing Technology provides redundant sealing capabilities to eliminate potential leaks. Monolithic diaphragm design enables maximum suction, priming, and continuous dry operation. Ideal for waste, transfer and bulk movement of liquids.

Features

- LTC Series Pumps set the highest benchmark for service free life-expectancy with our advanced proprietary diaphragm elastomer.
- Multiple port designs available for simple integration: Barb tubing connection, 6MM compression fitting, or 1/4-28 UNF threads with top and bottom face sealing.
- Overmolded diaphragm eliminates metal components in the wetted path resulting in a design that is inert to variety of media.
- Incorporating the lightweight EZ Mount Accessory facilitates simple system assembly while dampening vibration and reducing noise levels.
- Our 100% oil and grease-free pump and compressor design maintains the purity of your system and are commonly used in FDA-approved systems.
- RoHS Compliant 

Product Specifications*

Physical Properties

Operating Environment¹ :
41 to 122°F (5 to 50°C)
Storage Environment :
-4 to 212°F (-20 to 100°C)
Media:
Most Gases and Liquids
Humidity:
0 – 95% Relative Humidity
Pump Assembly Rated Life²:
PMDC Iron Core Brush - 3,000 hrs
Brushless Slotted - 10,000 hrs
Weight:
7.0 oz. (198 g) single head PMDC Iron Core Brush
5.0 oz. (142 g) single head Brushless Slotted
11.7 oz. (333 g) dual head Brushless Slotted (High Torque)

Electrical

Motor Type (DC):
PMDC Iron Core Brush, Brushless Slotted
Nominal Motor Voltages³:
12, or 24 VDC
<i>Other voltages available upon request</i>
Electrical Termination:
PMDC Iron Core Brush: 22 AWG Wire Leads, Length 10" (254 mm)
Brushless Slotted Motor: 22 AWG Wire Leads, Length 20" (508 mm)

Wetted Materials

Diaphragm:
EPDM, AEPDM, FKM, PTFE /EPDM Laminate
Valves:
EPDM, AEPDM, FKM, FFKM
Pump Head:
Vectra (Liquid Crystal Polymer)

Pneumatic

Head Configuration:
Single
Dual Head
Maximum Unrestricted Flow:
1.0 LPM single head
1.7 LPM dual head in parallel
Pressure Range (Liquid):
0 - 30 psig (0 - 193 kPa)
Vacuum Range (Air):
0 - 14.5 in Hg (0 - 368 mm Hg)
Filtration:
40 microns - recommended

* See Appendix A for details.



Performance Specifications

LTC Single and Dual Head Typical Flow

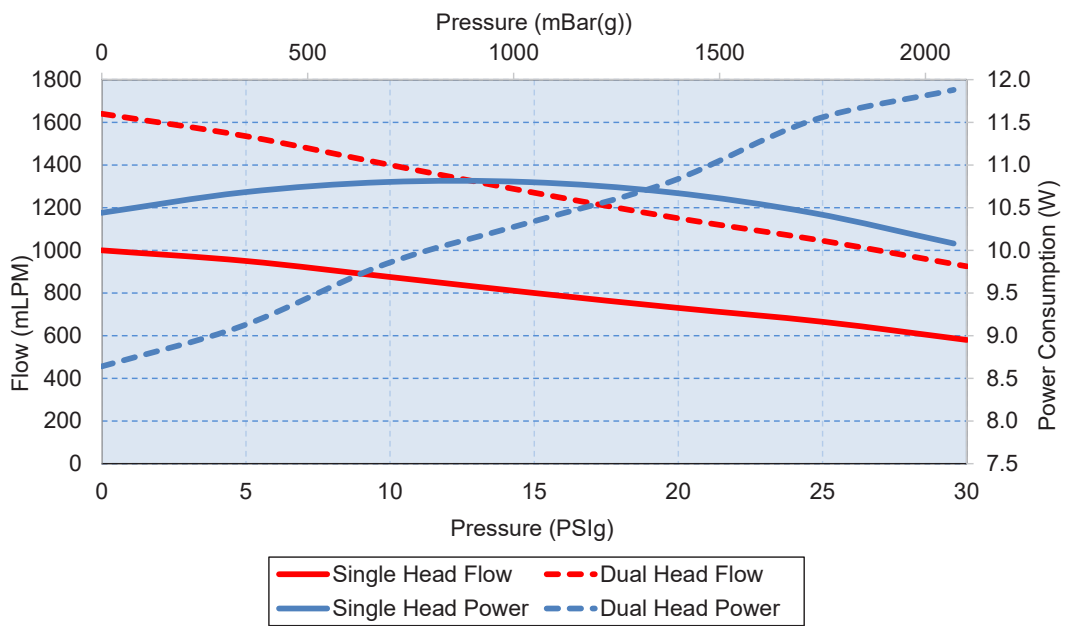

Typical flow performance is shown with standard high flow configurations with barb ports and brushless DC motor. Performance will vary depending on port and motor selection. Please contact Parker for the typical flow performance for a specific part number and configuration.

All LTC performance data is collected using water at 800 feet [244m] above sea level at 75°F [24°C]. Performance will vary depending on barometric pressure and media temperature. Curves are representative of standard pump configurations. Pump configurations could be customized for higher or lower flows, depending on specific customer requirements.

Please contact Parker Precision Fluidics Applications Engineering for other considerations.



Sizing and Selection

LTC Series

PMDC Iron Core Brush

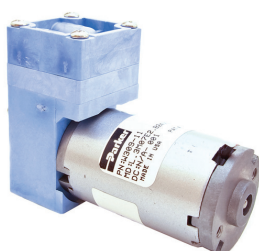

Brushless Slotted Motor



Brushless Slotted
(High Torque) Motor

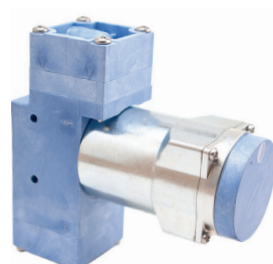

PMDC Iron Core Brush

BLDC Slotted Motor

Brushless Slotted (High torque) Motor

Efficiency¹	Good	Better	High Efficiency at high loads
Life²	Good - 3,000 hrs	Best - 10,000 hrs	Best - 10,000 hrs
Cost	Best	Better	Good

Barb Connection

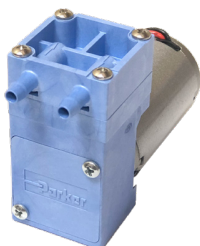

Compression Connection



Threaded Connection



Fittings/ Tubing	6mm OD, 4mm ID (or 1/4" OD)	6mm OD, 4mm ID (or 1/4" OD) Nut, Ferrule, and Retaining ring included	1/4"-28 UNF Bottom sealing or face sealing
-----------------------------	--------------------------------	---	---

Mounting Guidelines:

- Bracket options available for mounting consideration (See *EZ Mount catalog pages*).
- Hole in the center of the bottom of housing is for manufacturing only—not to be used for mounting.
- Mounting holes are drilled for #6-20 self-tapping screws with 1/4" (6 mm) thread engagement torque to 4 in-lbs (0.45 N-m).

Port Connections:

- Flow direction is marked on the pump head with arrows.
- Barb ports are designed for 1/4" or 6MM OD tubing
- Compression fittings are designed for 4MM ID / 6MM OD tubing
- Threaded ports are sized for 1/4"-28 UNF male fittings.

LTC Series

Miniature Diaphragm Pumps (liquid)

Mechanical Integration

Dimensions

Single head LTC PMDC Iron Core Brush

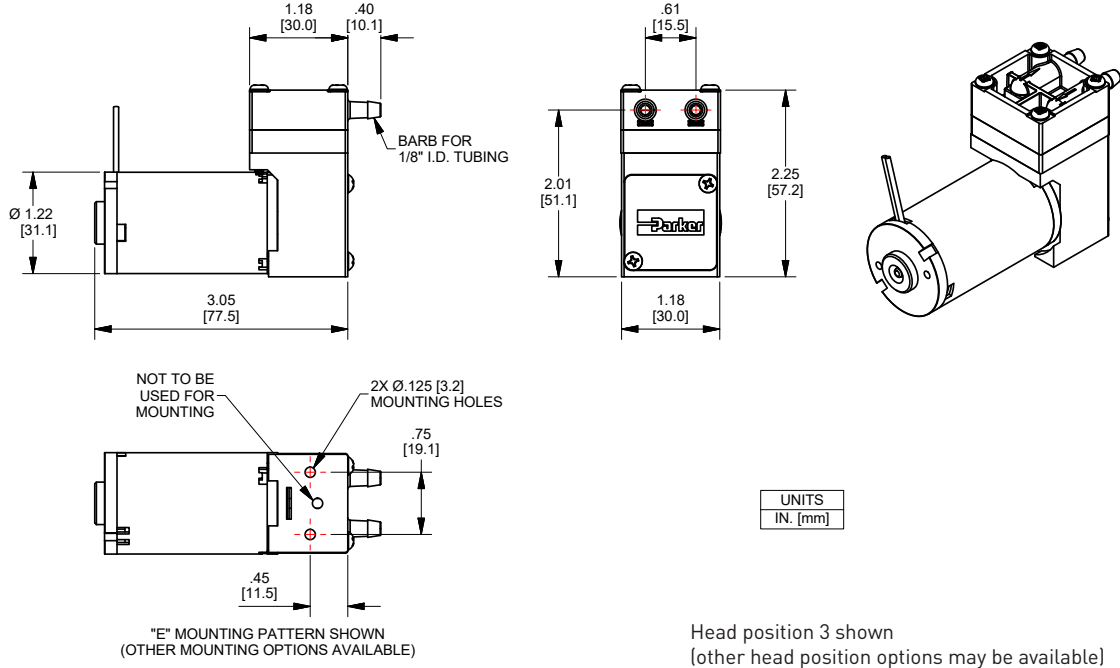

Single head LTC Brushless Slotted Motor

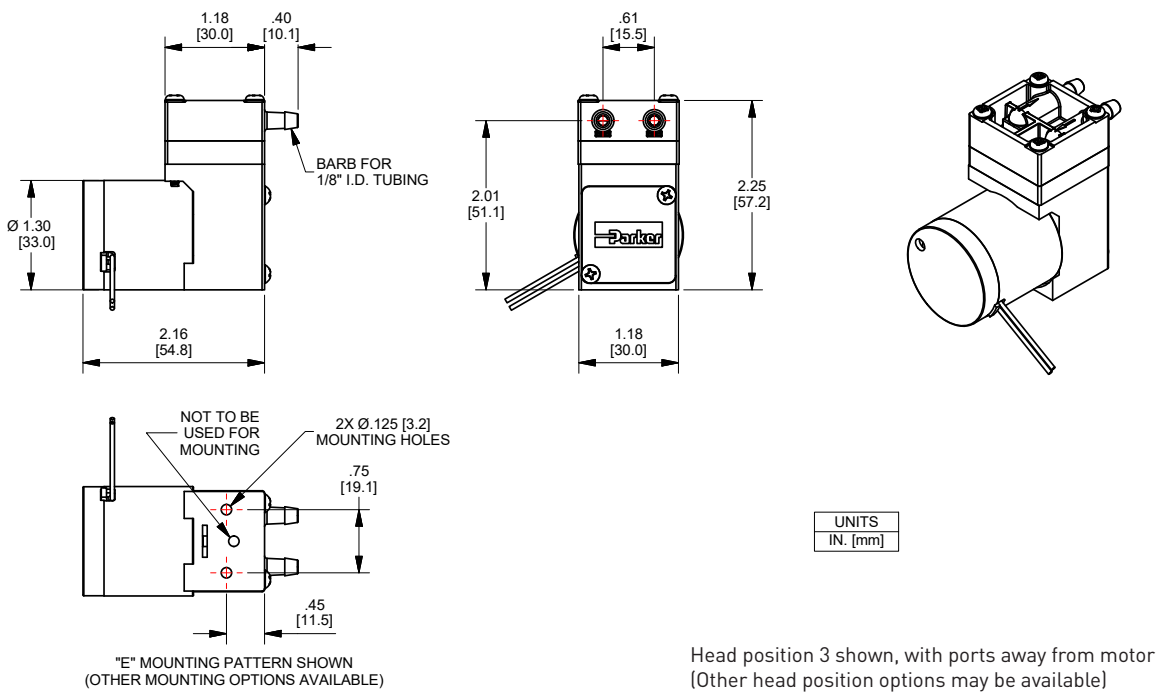

Mechanical Integration

Dimensions

Dual head LTC-IIS Brushless Slotted (High Torque) Motor

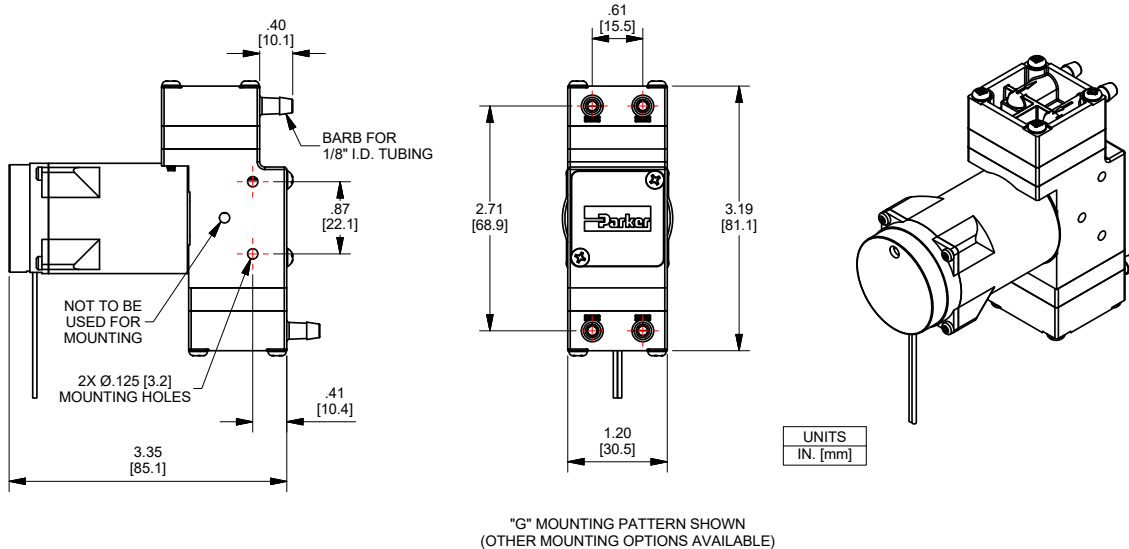

Head position 3 shown, with ports away from motor
(Other head position options may be available)

Electrical Integration and Motor Control

PMDC Iron Core Brush Motor

2 Wire	Red (+), Black (-)
Wire specification	22AWG, Insulation OD 0.051 in (1.30 mm) 10" (254 mm) Wire Leads

Brushless Motor Control Options

2 Wire	Red (+), Black (-)
Wire specification	22AWG, Insulation OD 0.051 in (1.30 mm) 20" (508 mm) Wire Leads

Other Motor Control Considerations

The drive electronics for the BLDC motors are integrated into the motor itself, all that is needed is a power supply with the sufficient voltage and current.

Key Things to Remember

The pump is not a pressure holding device. An external check valve is recommended, if there is a pressure holding requirement.

Pump orientation does not affect performance or life.

LTC Series

Miniature Diaphragm Pumps (liquid)

Typical Flow Diagram

LTC pump used for liquid transfer in a printing application

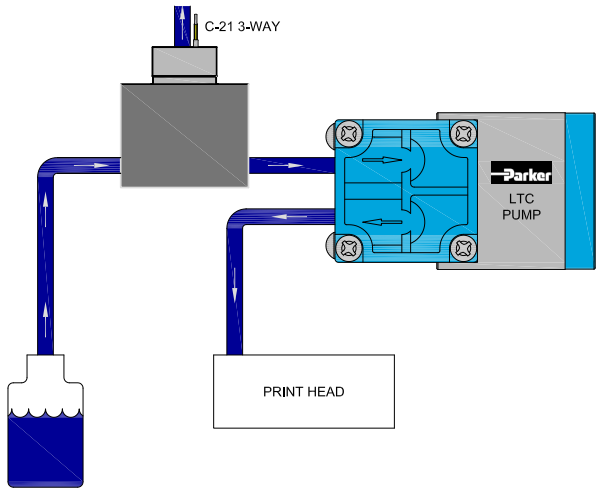

LTC Waste Pump

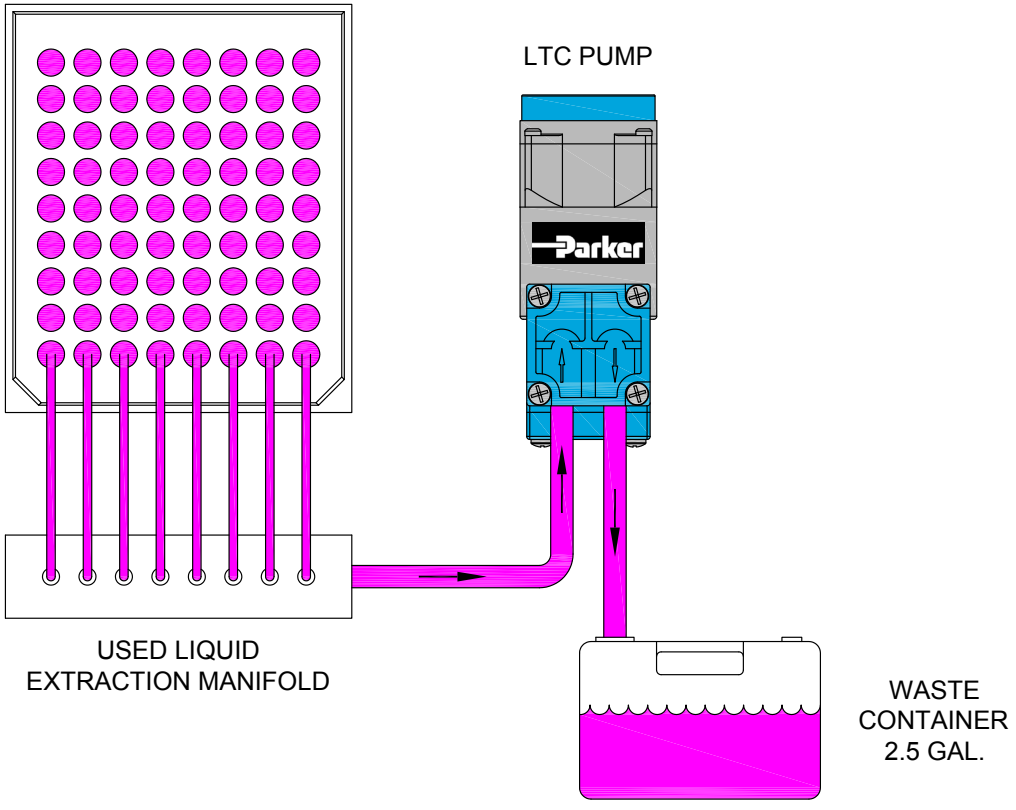

Accessory Information

EZ Mount available

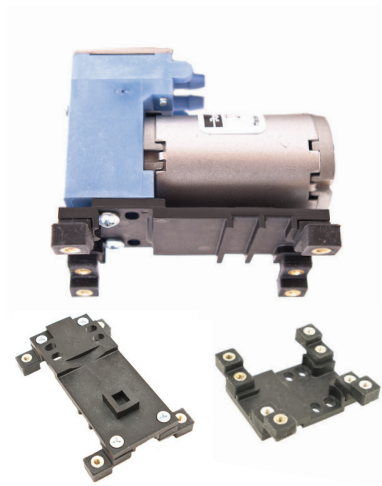

EZ Mount provides ease of installation and effective control of vibration transfer. EZ Mount was designed to mount easily to the Precision Fluidic LTC Family of diaphragm pumps.

Features

- Isolation feet on the EZ mount can be rotated in any one of three ninety-degree planes and is designed for top-down or bottom-up mounting providing simple installation.
- EZ Mount was designed to minimize weight added to the pump assembly. Approximate weights are: Style A - 0.63 oz (18 g), Style B - 0.71 oz (20 g).
- Effectively absorbs vibration to minimize most vibration-induced noise and vibration transfer into an instrument.
- Designed to keep height and size to a minimum.
- Engineered for Parker LTC and LTC-IIS pumps to ease integration into your system.

Physical Properties

Operating Environment:

41 - 158°F (5 - 70°C)

Humidity:

0 - 95% Relative Humidity

Base Plate:

Noryl GTX830

Feet:

Silicone

Feet Insert:

Brass

Hardware:

Zinc-Plated Steel

EZ Mount kits include all necessary hardware and detailed instructions.

Isolation Feet are available in either threaded or thru-hole clearance for standard #4-40 or #6-32 (M3 for clearance hole only) hardware and can be mounted in any of three ninety-degree planes.

Dimensions

Style A - Brushless Slotted Motor

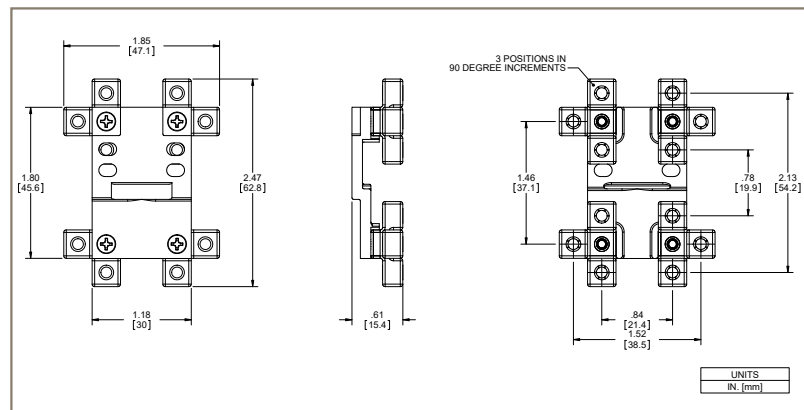

Style B - PMDC Iron Core Brush Motor

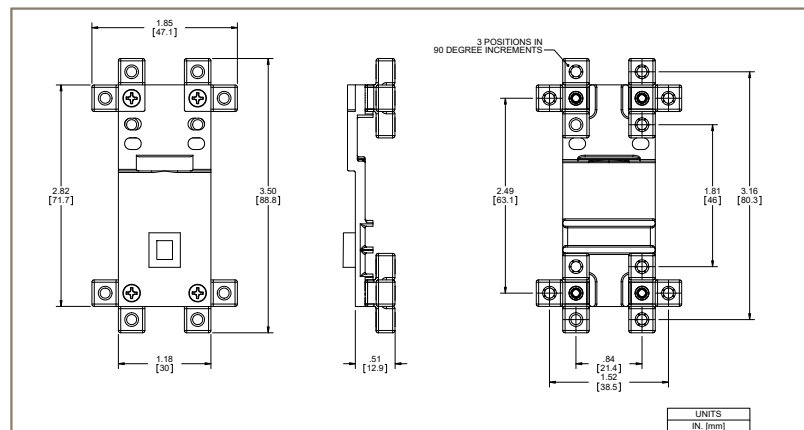

LTC Series

Miniature Diaphragm Pumps (liquid)

Accessory Information

Dimensions

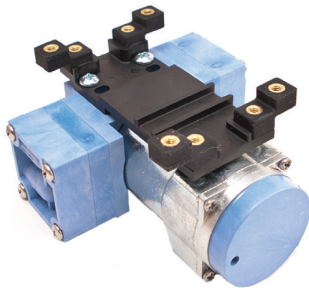

Style B - Brushless Slotted (High Torque) Motor

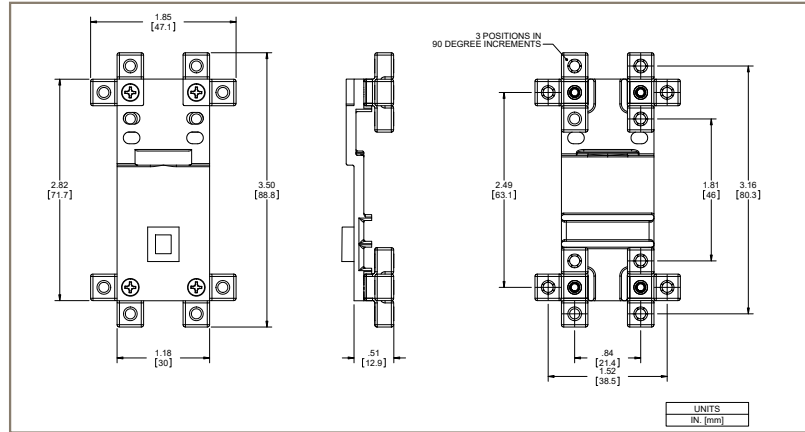

Ordering Information

EZ Mount for LTC Single Head Pump with PMDC Iron Core Brush Motor

Part Number	Style	Description
00329-10-A45S	B	#4-40 Threaded
00329-10-B45S	B	#4 Clearance
00329-10-D45S	B	#6-32 Threaded
00329-10-C45S	B	#6 / M3 Clearance

EZ Mount for LTC Single Head Pump with Brushless Slotted Motor

Part Number	Style	Description
00328-10-A45S	A	#4-40 Threaded
00328-10-B45S	A	#4 Clearance
00328-10-D45S	A	#6-32 Threaded
00328-10-C45S	A	#6 / M3 Clearance

EZ Mount for LTC-IIS Dual Head Pump with Brushless Slotted (High Torque) Motor

Part Number	Style	Description
00331-10-A45S	B	#4-40 Threaded
00331-10-B45S	B	#4 Clearance
00331-10-D45S	B	#6-32 Threaded
00331-10-C45S	B	#6 / M3 Clearance

LTC Compression Fitting Spares Kit

1. Black Knurled Nut - 20x
2. Metal Compression Sleeve - 20x
3. Plastic Compression Ferrule - 20x

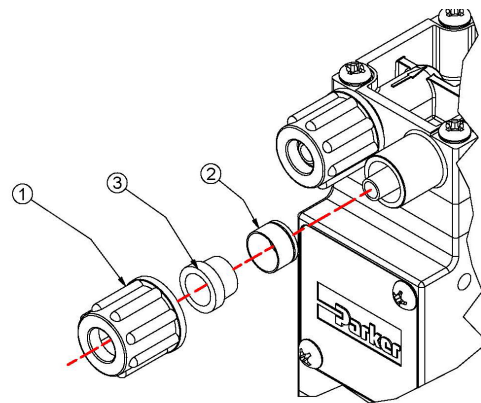

Part Number	Description	Comments
01842-KT	LTC Compression Fitting Spares Kit, 6MM	Kit includes 20 pieces of each fitting component



Miniature Diaphragm Pumps (liquid)

LTC Series

Chemical Compatibility Chart*

Chemical	Chemical Compatibility of Wetted Path Materials Temperature Range 5-50 Degrees C					
	FKM	FFKM	EPDM	AEPDM	PTFE	Vectra A130
DI Water	1	1	1	1	1	1
Methanol	4	1	1	2	1	1
Isopropanol	1	1	1	1	1	1
Ethanol	3	1	1	2	1	1
Acetonitrile	4	1	1	1	1	1
Organic Acids - Dilute	1	1	1	1	1	3
Non-Organic Acids - Dilute	1	1	1	1	1	3
Bases - Dilute	1	1	1	1	1	3
Saline	1	1	1	1	1	1
Bleach 12%	1	1	1	1	1	3
Ink (MEK)	4	1	1	2	1	1
Sodium Hydroxide 20%	2	1	1	2	1	3



Compatibility Legend

- EXCELLENT**
Minimal or no effect
- GOOD**
Possible swelling and/or loss of physical properties
- DOUBTFUL**
Moderate or severe swelling and loss of physical properties
- NOT RECOMMENDED**
Severe effect and should not be considered

Note: Consult factory for other gases.

*The above is an Abbreviated Chemical Compatibility Chart. Please consult factory for details. Temperature range for chart is 5-50° C. See Application Engineering for compatibility's with any specific acids or bases.

Ordering Information

Configuration	Voltage	Connection	Part Number	Liquid Flow (Water) mLPM @ Load						FF	Dry Vacuum inHg	Max Pressure (Water) PSig	Wetted Materials		
				0 psig 0 mbar	5 psig 345 mbar	10 psig 689 mbar	15 psig 1034 mbar	20 psig 1379 mbar	25 psig 1724 mbar				30 psig 2068 mbar	Diaphragm	Valves
 Brush Motor	12	Barb	W311-61	930	865	820	775	705	630	580	17.0	30.0	EPDM	AEPDM	EPDM
	12	Compression	W311-51	965	930	890	830	750	655	605	17.0	30.0	EPDM	AEPDM	EPDM
	12	1/4-28 Thread	W311-11	670	650	600	550	505	450	390	14.5	30.0	EPDM	AEPDM	EPDM
	24	Barb	W309-61	970	890	830	800	730	640	580	17.0	30.0	EPDM	AEPDM	EPDM
	24	Compression	W309-51	930	895	830	780	755	720	690	17.0	30.0	EPDM	AEPDM	EPDM
	24	1/4-28 Thread	W309-11	720	715	685	660	645	585	540	14.5	30.0	EPDM	AEPDM	EPDM
 Compact Brushless DC	12	Barb	W313-61	880	805	780	720	645	585	525	17.0	30.0	EPDM	AEPDM	EPDM
	12	Compression	W313-51	945	900	840	770	665	590	535	17.0	30.0	EPDM	AEPDM	EPDM
	12	1/4-28 Thread	W313-11	640	620	580	510	460	410	370	14.5	30.0	EPDM	AEPDM	EPDM
	24	Barb	W312-61	1000	950	875	800	730	655	580	17.0	30.0	EPDM	AEPDM	EPDM
	24	Compression	W312-51	1030	1000	930	860	790	690	605	16.0	30.0	EPDM	AEPDM	EPDM
	24	1/4-28 Thread	W312-11	640	630	570	510	455	415	375	14.5	30.0	EPDM	AEPDM	EPDM
 High Torque Brushless DC	12	1/4-28 Thread	V015-11	1500	1400	1300	1200	1100	1000	900	11.5	30.0	EPDM	AEPDM	EPDM
	24	Barb	V016-61	1640	1535	1400	1270	1150	1045	925	10.0	>60	EPDM	AEPDM	EPDM
	24	Compression	V016-51	1650	1540	1405	1265	1135	1020	895	11.0	>60	EPDM	AEPDM	EPDM
	24	1/4-28 Thread	V016-11	1500	1400	1300	1200	1100	1000	900	11.5	30.0	EPDM	AEPDM	EPDM

Note: The Ordering Information Section includes a few selected part numbers for the product line. Other performances and configurations are available. Please contact your Sales Representative or an Application Engineer to discuss your application needs.



LTC Series

Miniature Diaphragm Pumps (liquid)

Please click on the Order On-line button below (or go to www.parker.com/precisionfluidics/ltc) to configure your LTC Miniature Diaphragm Pump.

Serviceable – PPF products are designed for use through the rated life and Parker does not sell replacement parts, and these products are not meant to be serviced in the field. Please contact Customer Service with any questions.

Note: In addition to Parker's innovative and flexible pump designs, we offer applications engineering expertise to our customers in order to configure and recommend the optimal pump for the application. Contact Parker Applications Engineering to discuss and configure alternate pump configurations to meet your specific application requirements. Providing information on the following requirements will assist us in developing an optimal solution for your application:

- Noise
- Operating Pressure / Vacuum
- Power Consumption
- Life Requirement
- Description of pump function in the application
- Size
- Motor Control
- Media
- Voltage



Parker Hannifin Precision Fluidics Division reserves the right to make changes. Drawings are for reference only.

Appendix A

All performance data is typical based on standard conditions: 70°F and 14.7 psia (21°C and 1 bar).

1. Duty Dependent. For operation above 122°F (50°C) consult factory
2. Life rating can vary depending on application and operating conditions.
3. Custom motor options available. Custom motors may require a significant application potential. The standard motors can be configured with a special winding to meet a particular operation point at a specified voltage
4. Current range is dependent on motor type, voltage, pressure/vacuum and flow requirement. Lower levels possible depending on application.
5. Pump efficiency is a measure of the flow rate generated per unit of power consumed. Efficiency may change dependent on application and operating condition at free flow.

