

## Analog Output Sensor Cable for 0-10 V Voltage Output SCC1-Analog

- Configurable analog voltage output of the flow rate measurement
- Switch output with configurable threshold
- Volume integration by counting pulses
- Applicable to digital SLQ, SLI, SLS and SLG liquid flow meters



### Product Summary

The Analog Sensor Cable SCC1-Analog allows simple and quick readout of Sensirion's liquid flow meters by converting the digital sensor reading into an analog voltage output, configurable to any range within 0-10 V. Additionally, a digital (high/low) open drain output with two modes of operation is available (Flow Switch / Volume Counter).

In *Flow Switch* mode, the output is high or low depending on the momentary flow rate and two configurable threshold values.

In *Volume Counter* mode, a voltage pulse is generated every time a defined volume has flown through the flow meter.

## Content

1 Modes of Operation	3
2 Electrical Specifications	7
3 Mechanical Specifications	10
4 Ordering Information	10
5 Important Notices	11
6 Revision History	12
7 Headquarters and Subsidiaries	12

## 1 Modes of Operation

The SCC1-Analog sensor cable provides analog 0-10 V voltage output for Sensirion's Liquid Flow meters of the SLG, SLI, SLS and digital SLQ series. The cable's internal electronics read the I<sup>2</sup>C output of the sensor and converts it to the analog voltage signal and an optional digital open drain output.

The SCC1-Analog sensor cable is marked with a red sleeve next to the M8 sensor connector and with an imprint 0-10V 24V/xxxx on the cable, where xxxx denotes a lot code.

The cable is available in two variants with a total length of 2 meters or 10 meters, respectively.

### 1.1 Analog Voltage Output ( $V_{out}$ )

The voltage output provides a voltage which corresponds to the measured flow rate. The flow rate is linearly mapped to the voltage across a user-specified range, see Figure 1, and can be calculated by the following formula:

$$Flowrate = (V_{out} - V_{min}) \cdot \frac{Flow_{atVmax} - Flow_{atVmin}}{V_{max} - V_{min}} + Flow_{atVmin}$$

The parameters  $V_{max}$ ,  $V_{min}$ ,  $Flow_{atVmax}$  and  $Flow_{atVmin}$  can be configured by the user (see section 1.4 Configuration). They can be freely chosen in the range of the sensor's specifications.

By default, the SCC1-Analog sensor cable is set with 5 V output at no-flow, 0 V for negative maximum flow (sensor output limit), and 10 V for positive maximum flow (sensor output limit). The default calibration field accessed by SCC1-Analog can also be configured.

The sensor cable output voltage is capped at the voltage output limits  $V_{highLimit}$  and  $V_{lowLimit}$ . By default,  $V_{highLimit}$  is set to 10.5 V and  $V_{lowLimit}$  is set to 0 V. See Figure 1 below for an illustration of the different parameters.

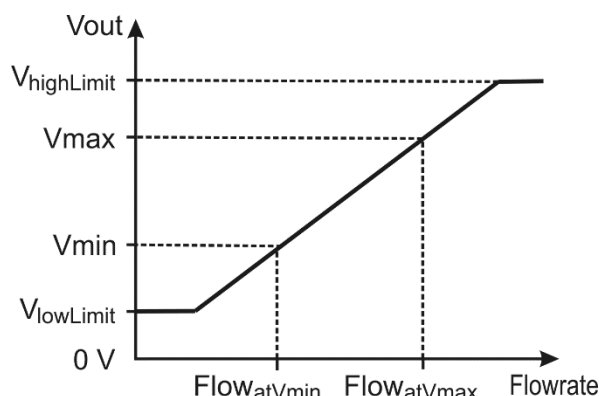

**Figure 1:** Scaling of the analog voltage output and definition of parameters.

#### Example:

The SLS-1500 has a maximum flow range (output limits) of +/-65 ml/min. If the whole flow range is to be covered by the analog voltage output, the parameters  $Flow_{atVmin}$  and  $Flow_{atVmax}$  are set to -65 ml/min and +65 ml/min, respectively, with  $V_{max}$  being 10 V and  $V_{min}$  being 0 V. (this is the default setting for this sensor). A measured voltage of 6.5 V at the voltage output is then converted to the actual flow rate as follows:

$$Flowrate = (6.5 V - 0 V) \cdot \frac{65 \text{ ml/min} - (-65 \text{ ml/min})}{10 V - 0 V} + (-65 \text{ ml/min}) = 19.5 \text{ ml/min}$$

## 1.2 Digital Open Drain Output

The digital output has only two logic states, high and low. Since the digital output is realized as an open drain (open collector) circuit, a pull-up resistor has to be connected between digital output and an external voltage  $V_{high}$ , which serves as the high-level voltage (see block diagram in Figure 6). The value of this high-level voltage may be chosen independently or identical to the supply voltage in order to match the logic levels of the system.

The different modes of operation for the digital output are described below. By default, the digital output is disabled, i. e. it is always low.

The mode of operation is configured using the configuration software. (See section 1.4 Configuration).

### Flow Switch

In this mode, the digital output is low when the measured flow is outside a specified flow range, and high when inside. This flow range is specified by two threshold values. Additionally, a hysteresis may be specified for each threshold value (see Figure 2).

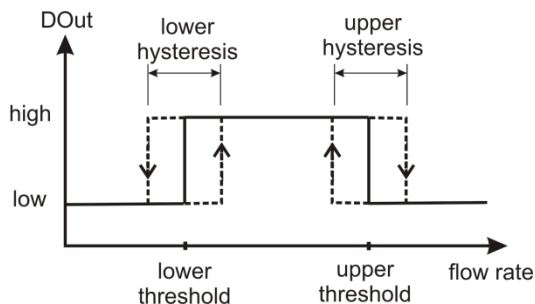

**Figure 2:** Flow Switch thresholds and definition of parameters.

When the flow switch mode is first enabled in the configurator, a lower threshold at 25% of the sensor's maximum flow rate with a hysteresis of +5% of the set point is suggested and the upper threshold is set above the maximum flow rate. Setting the upper threshold above the maximum flow rate is equivalent to disabling the upper threshold altogether.

### Volume Counter

In this mode, the SCC1-Analog cable's internal electronics calculates the accumulated volume based on the flow rate and every time a defined volume flows through the meter, a pulse is generated on the digital output. The total amount of liquid which has flown through the meter can be determined by simply counting the pulses and multiplying by the defined volume.

The liquid volume per output pulse and the duration of the output pulse can be configured.

The volume counter can be configured to ignore negative flow rates (flow in backward direction). If negative flow rates are *not* ignored, these are subtracted from the internally calculated volume. In this case, no output pulses are generated until the internal totalizer has again reached a positive value.

In order to reset the internal totalizer, the SCC1-Analog cable should be switched off for 1000 ms by interrupting the supply voltage.

When the Volume Counter is first enabled in the configurator, the suggested setting generates 0.5 ms long output pulses with a frequency of approx. 250 Hz at the maximum flow rate of the attached sensor.

### 1.3 Output Filter (for lot codes 1448 and higher)

Sensirion Liquid Flow sensors have a very fast response time and therefore react very quickly to changes in the flow rate. In some application a low-pass filtering of the sensor output may be desired e.g. to ignore short excursions of the flow rate above or below the switch thresholds. For this purpose, a moving average filter is available in the SCC1-Analog sensor cable. The filter is realized as moving average with a configurable time constant (2 milliseconds to 1 minute). The moving average can be applied to the analog voltage output, to the digital open drain output signal, to both outputs or to none of them. Figure 3, Figure 4, and Figure 5 show some examples of possible combinations and the resulting outputs on an oscillating flow rate with some interruptions of the flow. Such noisy flow rates are typical for certain pump types.

The filter time constant and signal selection (filtered/unfiltered) for each output may be configured using the configuration software. (See section 1.4 Configuration).

#### Example 1:

Filtered signal for the analog voltage output, unfiltered signal for the digital (switch) output.

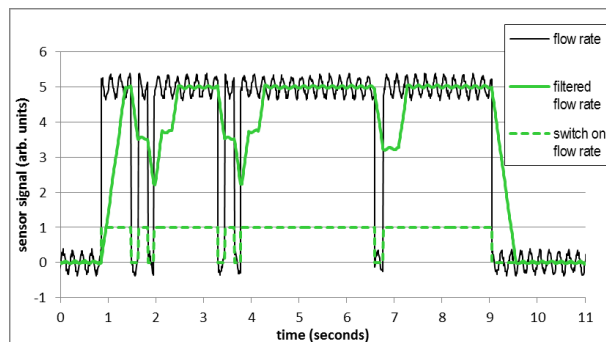

**Figure 3:** Cable output with moving average filter on flow rate (green solid line) and switch output on unfiltered flow rate (green dashed line). The black line shows the underlying unfiltered flow rate.

#### Example 2:

Filtered signal for both, analog voltage output and digital (switch output). Note the difference in the switching behavior between Figure 3 and Figure 4: In Figure 3 (unfiltered signal) the switch output follows the short dips in the flow rate immediately. In contrast, the switch output on the filtered signal (in Figure 4) is tolerant to such short excursions below the switch level.

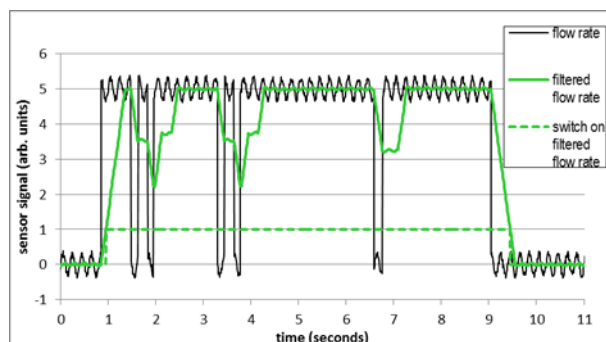

**Figure 4:** Cable output with moving average filter on flow rate (green solid line) and switch output on filtered flow rate (green dashed line). The black line shows the underlying unfiltered flow rate.

**Example 3:**

Unfiltered signal for the analog voltage output, filtered signal for the digital (switch) output. The analog voltage output follows the flow rate immediately, including the high-frequency oscillations of the pump and the short drops in the flow rate. On the other hand, the switch output on the filtered signal is tolerant to these short excursions below the switch threshold.

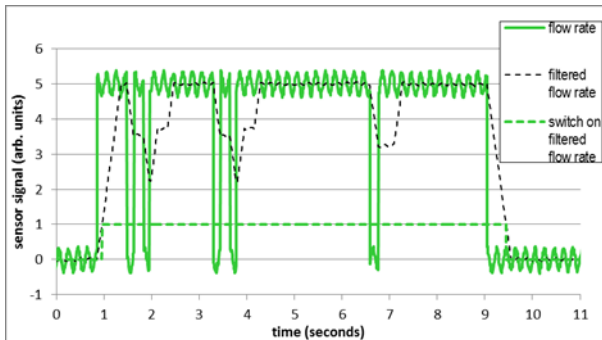

**Figure 5:** Cable output with unfiltered flow rate (green solid line) and switch output on filtered flow rate (green dashed line). The black dashed line shows the underlying filtered flow rate.

**1.4 Configuration**

The output configuration settings for the SCC1-Analog sensor cable are stored in the memory of the flow meter, not in the SCC1-Analog sensor cable. The configuration is written to the flow meter’s memory using an SCC1-USB sensor cable and the configurator software which is available on the Sensirion webpage. Once the flow meter is configured, any SCC1-Analog cable can be connected to the flow meter. The internal electronics in the cable will then read the settings from the flow meter’s memory and start operation on power-up.

The necessary steps are summarized below:

- 1) Connect the flow meter to a PC using the SCC1-USB sensor cable.
- 2) Open the Analog Sensor Cable Configurator software. Write your settings. Note that the same configurator software is also used for the SCC1-Current 0-20 mA current output cable.
- 3) Disconnect the flow meter from the SCC1-USB sensor cable and reconnect with the SCC1-Analog sensor cable. The SCC1-Analog sensor cable will now read the output configuration from the flow meter and continuously update the output as soon as it is powered up.

**1.5 Parameter Versions and Backwards Compatibility**

Some parameters and features have been added since the introduction of the SCC1-Analog sensor cable. If the corresponding settings are present on a given sensor, these are ignored by old cables. If these settings are not programmed on a given sensor, a new cable will override the missing setting by the corresponding default value.

Settings version	0	1	2
Cable lot codes	initial	1448 and higher	1739 and higher
Output filter	disabled	Configurable, default disabled	
V <sub>max</sub>	Fixed to 10 V	Configurable, default 10 V	
V <sub>highLimit</sub>	Fixed to 10.5 V	Configurable, default 10.5 V	
V <sub>min</sub>	Fixed to 0 V		Configurable, default 0V
V <sub>lowLimit</sub>	Fixed to 0 V		Configurable, default 0V

**Table 1:** Cable version overview

## 2 Electrical Specifications

### 2.1 Electrical Characteristics

Default conditions of 25 °C and 24 V supply voltage apply to values in the table below, unless otherwise stated.

Parameter	Symbol	Conditions	Min	Typ.	Max	Unit	Comment
Supply voltage	V <sub>DD</sub>		12	24	36	V	
Power consumption	-	V <sub>DD</sub> = 24 V, R <sub>load</sub> = 10 kOhm		105		mW	Does not include power dissipated in pull-up resistor of the digital open drain output.
Analog voltage output	V <sub>out</sub>		0		10.5	V	
Current load analog voltage output	-				10.5	mA	
Analog voltage output load resistor	R <sub>load</sub>		1.0			kOhm	
Analog voltage output accuracy	-	V <sub>out</sub> = 0 V		±5	±20	mV	Accuracy of the digital-to-analog conversion in the SCC1-Analog sensor cable. See the flow meter's datasheet for the accuracy of the flow meter.
		V <sub>out</sub> = 10 V		±5	±40	mV	
Analog voltage output resolution	-			2.6		mV	Nominal resolution of internal DAC.
Digital open drain output sink current	I <sub>sink</sub>				15	mA	Sink currents exceeding 30 mA may trigger the sensor cable's internal thermal fuse resistor.
Digital open drain output pull-up resistor	R <sub>pull-up</sub>	V <sub>high</sub> = 24 V	1.8	2.2		kOhm	Pull-up resistor depends on desired high-level and input characteristics of read out device.
Digital open drain output high-level voltage	V <sub>high</sub>				24	V	
Digital open drain output low-level voltage	-	R <sub>pull-up</sub> = 1.8 kOhm, V <sub>high</sub> = 24 V			600	mV	The low-level voltage depends on the high-level voltage and the value of the pull-up resistor.

**Table 2:** Electrical specifications

## 2.2 Absolute Maximum Ratings

Stress levels beyond those listed in Table 3 may cause permanent damage to the device. These are stress ratings only and functional operation of the device at these conditions cannot be guaranteed. Exposure to the absolute maximum rating conditions for extended periods may affect the reliability of the device.

Parameter	Rating
Supply voltage, $V_{DD}$	0 V to 40 V
Digital output high voltage, $V_{high}$	0 V to 26.4 V
Operating temperature range <sup>1</sup>	-25 °C to +80 °C (fixed installation)
	-5 °C to +80 °C (moving installation)
Storage temperature range <sup>2</sup>	-40 °C to +105 °C

**Table 3:** Absolute maximum ratings.

## 2.3 Wire Assignment

One side of the SCC1-Analog sensor cable is connected to the 4 Pin M8 connector of Sensirion's liquid flow meters. The other side has four wires: Two for power supply and one for each output (analog voltage and digital open drain output). The outputs should be measured as indicated in the block diagram of Figure 6 and the wire assignment is stated in Table 4.

### **WARNING!**

Incorrect connection may lead to permanent damage of the cable. Check the wire assignment carefully.

Wire	Function	Symbol
Blue	Supply voltage	$V_{DD}$
White	Ground	GND
Brown	Analog voltage output	$V_{out}$
Black	Digital open drain output	$D_{out}$

**Table 4:** Wire assignment.

<sup>1</sup> Operating temperature of the SCC1-Analog sensor cable. See the flow meter's datasheet for the operating temperature of the flow meter.

<sup>2</sup> The recommended storage temperature range is 10-50°C.



## 2.4 Connection Diagram

A load resistor  $R_{load}$  should be placed between the voltage output ( $V_{out}$ ) and GND. Typically, this load resistor is already incorporated into the voltage readout device. The load resistor (or input impedance) of the voltage measurement input must be at least 1 kOhm, while 10 kOhm or larger is typical.

The voltage of the digital output ( $V_{DOut}$ ) should be measured with respect to GND, as indicated in the connection diagram of Figure 6. Make sure that the ground of the power supply is connected to the reference voltage of the readout device.

In order to use the digital open drain output, the  $D_{out}$  wire needs to be connected to the high voltage  $V_{high}$  by an external pull-up resistor  $R_{pull-up}$ . The value of the pull-up resistor has to be chosen in accordance with the input characteristics of the readout device. For a high-resistance device such as a volt meter a 10 kOhm pull-up resistor is typically suitable. On some programmable logic controllers (PLCs) the digital inputs may have a low input resistance and in such a case e.g. a 2.2 kOhm pull-up resistor should be used.

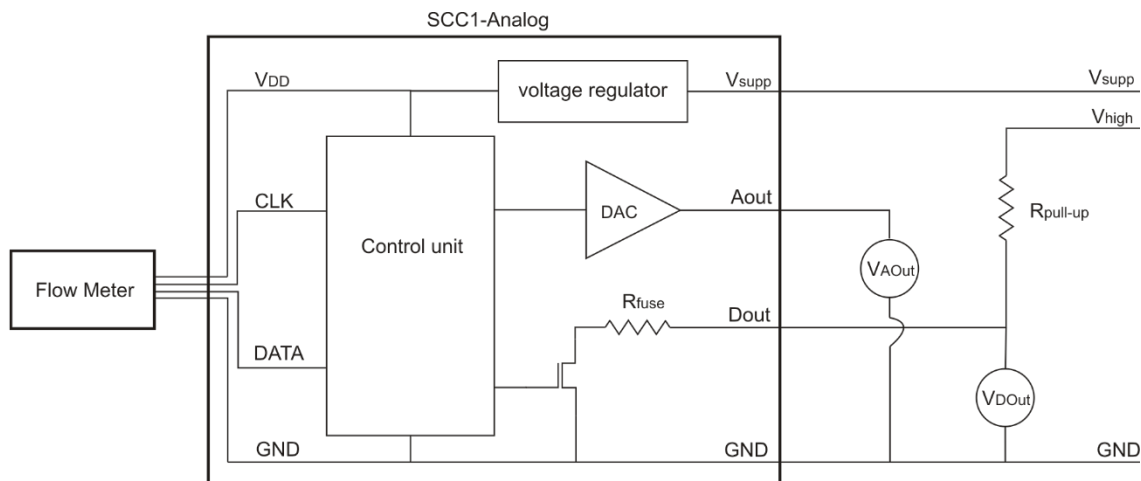

**Figure 6:** Internal block diagram of the SCC1-Analog Sensor Cable and measurement setup.

## 2.5 Notes on Operation

The cable is in general not short-circuit proof and does not have inverse polarity protection. Incorrectly connecting the cable may therefore cause damage to the cable.

Strong electrical interference on the short distance between the flow meter and the cable electronics may disturb the digital communication between the cable and the sensor. Such interference should therefore be avoided.

### 3 Mechanical Specifications

#### 3.1 Dimensions

Approximate mechanical dimensions of the electronics overmold are shown in Figure 7, dimensions and specifications of the cable are listed in Table 5.

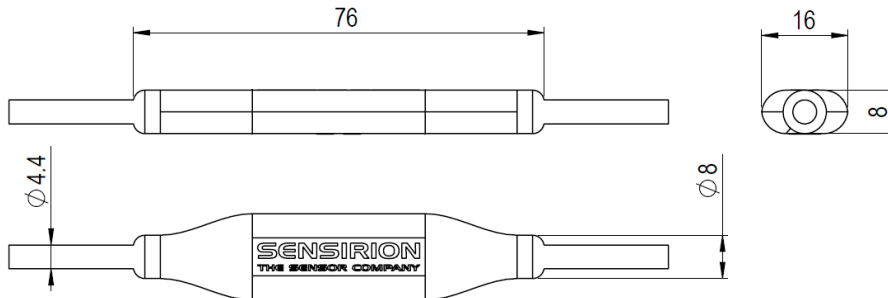

**Figure 7:** Mechanical dimensions of electronics overmold.

Parameter	Value
Length of cable on sensor side (including M8 connector)	~10 cm
Length of cable on pigtail end (2m version, 10m version)	~190 cm, ~990 cm
Cable outer jacket diameter on pigtail end	4.4 ± 0.2 mm
Conductor cross section	0.25 mm <sup>2</sup> (24 AWG)
Outer diameter of individual wires	1.15 ± 0.05 mm
Minimum bending radius <sup>3</sup>	10x cable diameter

**Table 5:** Mechanical specifications

#### 3.2 Materials

Part	Material
Cable jacket	PUR
Wire insulation	PP
Connector housing	PUR
Connector screw ring	Metal
Electronics overmold	Polyamide hotmelt
Color code sleeve	Polychloroprene

**Table 6:** List of materials

### 4 Ordering Information

Product code	Product description	Article number
SCC1-Analog 2m	SCC1-Analog 0-10V Sensor Cable 2m 24V DC, M8 Sensor Connector to Pigtail	1-101072-01
SCC1-Analog 10m	SCC1-Analog 0-10V Sensor Cable 10m 24V DC, M8 Sensor Connector to Pigtail	1-101219-01

**Table 7:** Ordering Information

<sup>3</sup> Bending radius of the cable. Avoid excessive and repetitive bending at the transition of the cable to the overmold.

## 5 Important Notices

### 5.1 Warning, Personal Injury

**Do not use this product as safety or emergency stop devices or in any other application where failure of the product could result in personal injury. Do not use this product for applications other than its intended and authorized use. Before installing, handling, using or servicing this product, please consult the data sheet and application notes. Failure to comply with these instructions could result in death or serious injury.**

If the Buyer shall purchase or use SENSIRION products for any unintended or unauthorized application, Buyer shall defend, indemnify and hold harmless SENSIRION and its officers, employees, subsidiaries, affiliates and distributors against all claims, costs, damages and expenses, and reasonable attorney fees arising out of, directly or indirectly, any claim of personal injury or death associated with such unintended or unauthorized use, even if SENSIRION shall be allegedly negligent with respect to the design or the manufacture of the product.

### 5.2 ESD Precautions

The inherent design of this component causes it to be sensitive to electrostatic discharge (ESD). To prevent ESD-induced damage and/or degradation, take customary and statutory ESD precautions when handling this product.

### 5.3 Warranty

SENSIRION warrants solely to the original purchaser of this product for a period of 12 months (one year) from the date of delivery that this product shall be of the quality, material and workmanship defined in SENSIRION's published specifications of the product. Within such period, if proven to be defective, SENSIRION shall repair and/or replace this product, in SENSIRION's discretion, free of charge to the Buyer, provided that:

- notice in writing describing the defects shall be given to SENSIRION within fourteen (14) days after their appearance;
- such defects shall be found, to SENSIRION's reasonable satisfaction, to have arisen from SENSIRION's faulty design, material, or workmanship;
- the defective product shall be returned to SENSIRION's factory at the Buyer's expense; and
- the warranty period for any repaired or replaced product shall be limited to the unexpired portion of the original period.

This warranty does not apply to any equipment which has not been installed and used within the specifications recommended by SENSIRION for the intended and proper use of the equipment. EXCEPT FOR THE WARRANTIES EXPRESSLY SET FORTH HEREIN, SENSIRION MAKES NO WARRANTIES, EITHER EXPRESS OR IMPLIED, WITH RESPECT TO THE PRODUCT. ANY AND ALL WARRANTIES, INCLUDING WITHOUT LIMITATION, WARRANTIES OF MERCHANTABILITY OR FITNESS FOR A PARTICULAR PURPOSE, ARE EXPRESSLY EXCLUDED AND DECLINED.

SENSIRION is only liable for defects of this product arising under the conditions of operation provided for in the data sheet and proper use of the goods. SENSIRION explicitly disclaims all warranties, express or implied, for any period during which the goods are operated or stored not in accordance with the technical specifications.

SENSIRION does not assume any liability arising out of any application or use of any product or circuit and specifically disclaims any and all liability, including without limitation consequential or incidental damages. All operating parameters, including without limitation recommended parameters, must be validated for each customer's applications by customer's technical experts. Recommended parameters can and do vary in different applications.

SENSIRION reserves the right, without further notice, (i) to change the product specifications and/or the information in this document and (ii) to improve reliability, functions and design of this product.

Copyright© 2017, by SENSIRION.

CMOSens® is a trademark of Sensirion

All rights reserved

## 6 Revision History

Date	Version	Page(s)	Changes
February 2014	1	all	First release
March 2014	2	all	Editorial changes
November 2014	3	all	Add new configuration parameters $V_{max}$ and $V_{highLimit}$ Add output filter and description 10 m variant of cable added
April 2016	4	Notes	Editorial changes
October 2017	5	all	Adapt to new format General editorial rework Add new configuration parameters $V_{min}$ and $V_{lowLimit}$

## 7 Headquarters and Subsidiaries

### Sensirion AG

Laubisruetistr. 50  
CH-8712 Staefa ZH  
Switzerland

phone: +41 44 306 40 00  
fax: +41 44 306 40 30  
[info@sensirion.com](mailto:info@sensirion.com)  
[www.sensirion.com](http://www.sensirion.com)

### Sensirion Taiwan Co. Ltd

phone: +886 3 5506701  
[info@sensirion.com](mailto:info@sensirion.com)  
[www.sensirion.com](http://www.sensirion.com)

### Sensirion Inc., USA

phone: +1 312 690 5858  
[info-us@sensirion.com](mailto:info-us@sensirion.com)  
[www.sensirion.com](http://www.sensirion.com)

### Sensirion Japan Co. Ltd.

phone: +81 3 3444 4940  
[info-jp@sensirion.com](mailto:info-jp@sensirion.com)  
[www.sensirion.co.jp](http://www.sensirion.co.jp)

### Sensirion Korea Co. Ltd.

phone: +82 31 337 7700~3  
[info-kr@sensirion.com](mailto:info-kr@sensirion.com)  
[www.sensirion.co.kr](http://www.sensirion.co.kr)

### Sensirion China Co. Ltd.

phone: +86 755 8252 1501  
[info-cn@sensirion.com](mailto:info-cn@sensirion.com)  
[www.sensirion.com.cn](http://www.sensirion.com.cn)

To find your local representative, please visit [www.sensirion.com/distributors](http://www.sensirion.com/distributors)